

Vega EMS-1

Universal Engine Monitoring System

Operating Manual – English 1.14

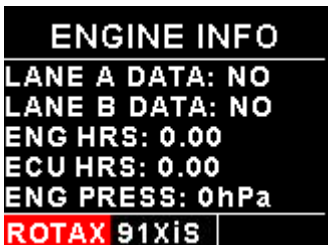
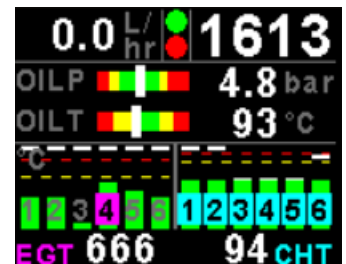
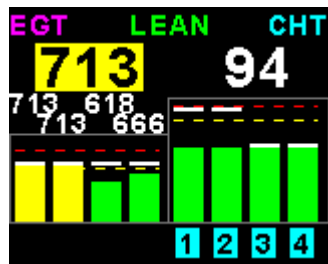
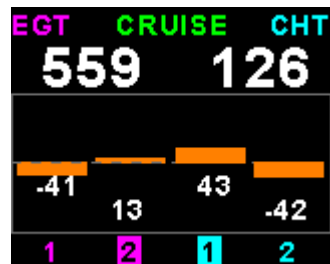
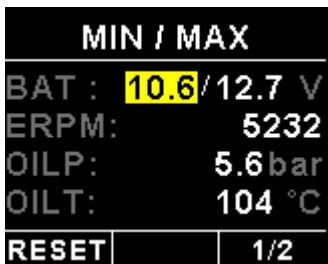
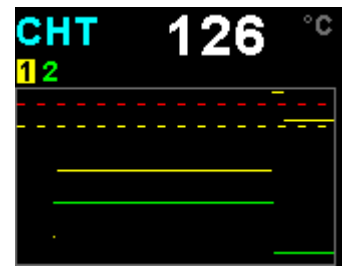
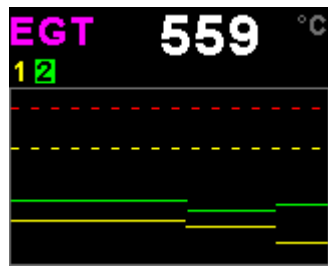
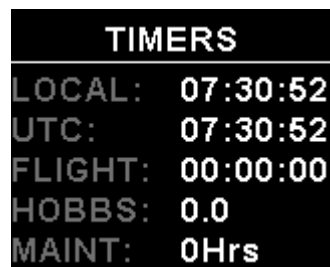
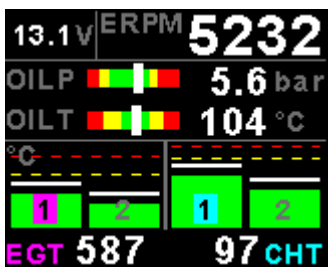

Introduction

The Vega EMS-1 is a 2 1/4" (57mm) universal engine monitor color display instrument. The EMS-1 contains all the necessary functionality to replace several engine monitoring instruments.

All information is displayed in an easy to read format on a high resolution wide viewing angle 1.8" 1000cd/m2 sunlight readable color display.

The EMS-1 light weight, small size and high level of functionality makes it an excellent choice for all types of engines. The EMS-2 can also interface directly to UL Power engines via the RS232 port.

The EMS-1 can also be interfaced via the CAN bus to an optional external RDAC unit (Remote Data Acquisition Computer). This allows for easier installation as the RDAC unit is normally mounted in the engine compartment.

1 Features

- Large 1.8" high resolution 160x128, sunlight readable, wide viewing angle, 1000 cd/m2 TFT LCD display
- The engine display screen is automatically configured to optimize screen space depending on what engine parameters have been selected
- Optional External RDAC (Remote Data Acquisition Computer) interfacing via the CAN bus
- Standard 2 1/4" (57mm) aircraft enclosure (can be front or rear mounted)
- Rotary control plus 2 independent buttons for easy menu navigation and user input
- An external output activates when a alarm condition has been reached
- Includes a RS232 serial output for interfacing to external equipment e.g. dataloggers etc.
- Wide input supply voltage range of 8 to 30V DC
- 1 year limited warranty

EGT/CHT

- Can measure up to 4 thermocouple channels using the internal electronics or up to 12 thermocouple channels using an optional external RDAC
- EGT/CHT Temperatures can be displayed in °C or °F from -100°C to 1200°C (-148°F to 2192°F)
- High accuracy: Built in thermocouple linearization curves and cold junction compensation
- Includes an EGT/CHT trend graph display of each thermocouple channel
- Records maximum EGT/CHT temperature reached for each channel
- Includes an engine leaning feature
- Includes an engine cruise feature
- Special Rotax 912/914 engine monitor mode utilizing the standard built in Rotax NTC CHT probes

RPM

- Single or dual RPM measurement
- Includes a magneto check function
- RPM can be displayed in RPM or in percentage
- Records maximum RPM reached for each channel

Fuel Flow (Uses RPM 2 Input)

- Single fuel flow measurement
- Fuel flow can be displayed in L/hr or in G/hr
- Includes a virtual calculated fuel tank

Fuel Level

- Analog inputs can be used to measure fuel level
- Fuel level can be displayed in Litres or Gallons
- Standard automotive fuel level senders can be used, even with odd shaped tanks due to a comprehensive, multi-point calibration system

Analog Inputs

- Can measure up to 4 Analog channels
- Analog channels are universal and can be configured to measure Pressure, Temperature, Current, Fuel Level or as a generic analog input
- Current measurement requires a MGL Avionics Closed Loop Current Sensor
- Pressure can be measured using standard automotive resistive senders (e.g. VDO 2, 5 and 10Bar), Rotax 4-20mA senders as well as voltage output pressure senders (e.g. UMA)
- Temperature can be measured using standard automotive resistive senders (e.g. VDO, Westach) as well as the MGL Avionics precision LM335 semiconductor sensor
- Fuel level can be measured using standard automotive fuel level senders, even with odd shaped tanks due to a comprehensive, multi-point calibration system
- High accuracy: Built in linearization curves for common senders
- Analog channels can be programmed to a user defined curve for custom senders
- Supports the Rotax 4-20mA pressure sender as used in the 912/914 engines
- Temperatures can be displayed in °C or °F
- Pressure can be displayed in psi or bar
- Fuel level can be displayed in Litres or Gallons
- Records minimum and maximum values reached for each channel

Manifold Pressure

- Manifold pressure can be displayed in millibar (mB) or in inches of Mercury (“Hg”).
- Records maximum MAP reached in permanent memory
- MGL Avionics RDAC-XF MAP required

Timers

- Displays both UTC (Zulu time) and local time
- Time is maintained by an internal lithium battery which can be replaced by the user
- Includes a settable Hobbs meter which is password protected
- Includes an engine running and flight timer
- Includes a programmable maintenance timer for scheduled routine engine maintenance
- Provides a 50 entry flight log that stores the start time and duration of each of the last 50 flights. The flight timer can either be started automatically or by using a front push button

Volts

- Can measure voltages up to 30V (compatible with both 12V and 24V aircraft supplies)
- Contains a programmable low/high voltage alarm to automatically detect alternator failures and bad batteries
- Records maximum and minimum Volts reached in permanent memory

Current (RDAC connection)

- Uses the Closed Loop Current Sensor (sold separately) to measure the aircrafts current load.
- Records maximum and minimum current reached in permanent memory

UL Power ECU Display

- Displays engine information from the UL Power ECU (Engine Control Unit) via the RS232 port
- The EMS-1 has a dedicated UL Power ECU display screen
- Displays warning messages from the UL Power ECU
- Supports the ULPower Aux box

ROTAX 912iS and 915iS ECU support

- The EMS-1 can connect to the ROTAX 912iS / 915iS ECU directly or by using the MGL Avionics RDAC CAN 912iS
- Displays engine information from the ROTAX 91XiS ECU
- The EMS-1 has dedicated ROTAX 91XiS display screens
- Displays Engine, Sensor and Device Status messages from the ROTAX 91XiS ECU

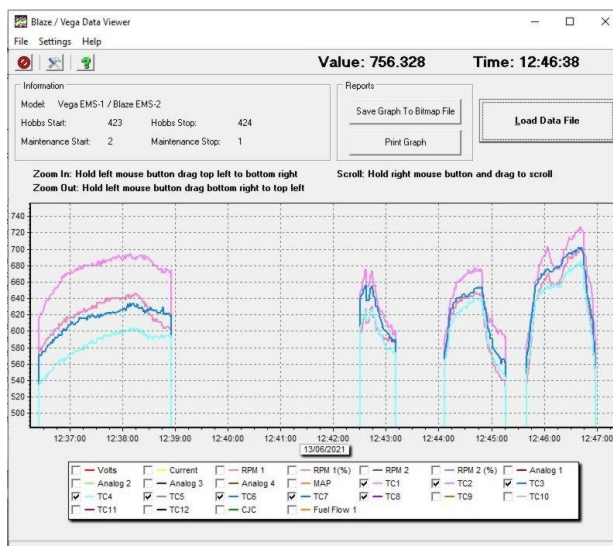

2 Layout



2 1/4" enclosure.
Can be front or rear mounted

Sunlight readable color graphic display:
Backlight can be adjusted in the menu system

F1 / Up Button:
Menu System: Softkey button
Normal Display: Start / Stop the flight timer (Manual flight only)

F2 / Down Button:
Menu System: Softkey button
Normal Display: Enable/disable Engine Leaning and Cruise mode

Rotary Control (Up/Down) & Enter Button:
Press the rotary control during the normal display screens to access the menu system. Rotate anti/clockwise for up/down menu scrolling. Rotate the rotary control during the normal display mode to view the Timers, Trend Graphs and the Max Values display.

3 Main Displays

The EMS-1 display screen is automatically configured to optimize screen space depending on which engine parameters have been selected. The Timers display, Trend graph and Max Values display can be selected by rotating the rotary control.

RPM / MAP / Volts / Fuel flow display section

Analog Channel section
(Pressure / Temperature / Current / Volts / MAP/ Fuel Level)

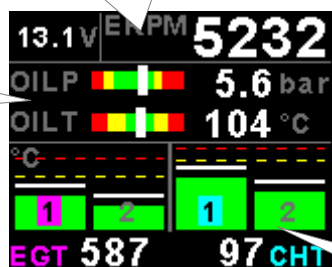

EGT/CHT display section

RPM / MAP / Volts / Fuel Flow display section

The RPM / MAP / Volts display section will maximize the space according to which parameters are enabled.

	Single RPM displayed
	Volts only displayed
	MAP only displayed
	Single RPM and Volts displayed
	Single RPM and MAP displayed
	Dual RPM displayed, RPM 2 in percent
	Single RPM and Fuel flow

Analog Channel section (Pressure / Temperature / Current / Volts / MAP / Fuel Level (Physical and calculated tank) / Generic input)

The Analog channels display section will maximize the space according to which parameters are enabled. MAP and Current can also be displayed in a bargraph format. If more then 2 parameters are displayed then the EMS-1 will alternate the display at 2 second intervals.

--	--	--	--

EGT/CHT display section

The Vega EMS-1 supports up to 4 thermocouples (using the internal electronics) and up to 12 thermocouples (using the optional external RDAC). The EGT/CHT section will automatically try and maximize the display area according to the number of EGTs/CHTs selected. The EGT/CHT parameters can be configured in the "EGT SETUP" and "CHT SETUP" menu.

The EGT/CHT number will highlight to the indicated the temperature value if "HIGHEST" is selected. The EGT highlight color is magenta, and the CHT color is cyan.

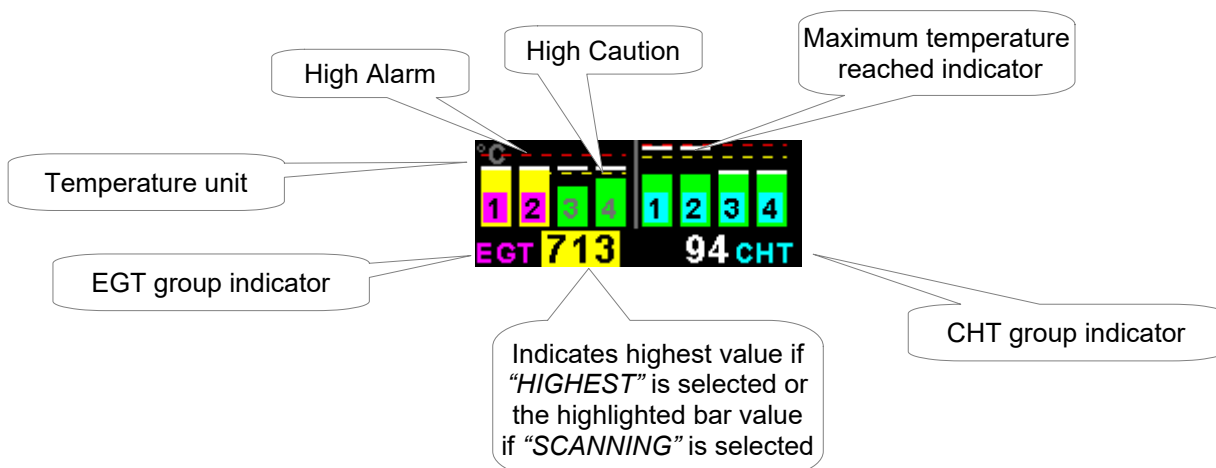

3.1 Timers display

TIMERS	
LOCAL:	09:41:54
UTC:	09:41:54
FLIGHT:	00:00:00
HOBBS:	0.0
MAINT:	0Hrs

LOCAL:

Local time normally includes an offset from UTC time. The time offset can be setup in the *"TIMERS SETUP"* menu.

UTC:

This is also known as Zulu or GMT time. The UTC time can be set in the *"TIMERS SETUP"* menu.

FLIGHT:

The flight time is automatically reset to zero when a new flight is started (manual or automatic flight detection). The ":" will flash when a flight is active. The flight timer can be started pressing the F1/UP key (Manual flight mode).

HOBBS:

The Vega EMS-1 contains a password protected Hobbs timer. The Hobbs time can be set to the current known engine time in the *"TIMERS SETUP"* menu. The Hobbs timer will only increment when the RPM is greater than the *"HOBBS RPM"*.

MAINT: (Maintenance Timer)

This timer is set in engine hours and it will count down to zero when the engine RPM is greater than the *"HOBBS RPM"* value as set in the *"TIMERS SETUP"*. A good use for this function is to set the hours until your next spark plug change or engine inspection.

The purpose of this function is to assist you in determining remaining hours until maintenance will be required. It is not intended as a replacement for the aircraft's maintenance log. It is therefore important that the aircraft's maintenance log be maintained in the normal manner. You should further use your own discretion in performing maintenance earlier than indicated should any aircraft performance problems arise.



A maximum of 999 hours can be entered as a maintenance interval. A reminder message will appear on startup when zero hours are remaining. The reminder message will disappear after the pilot presses any key. Engine running time for the purpose of the maintenance timer is defined as the run time where the engine RPM is greater than the *"HOBBS RPM"* value as set in the *"TIMERS SETUP"*.

3.2 EGT/CHT Trend Graph display

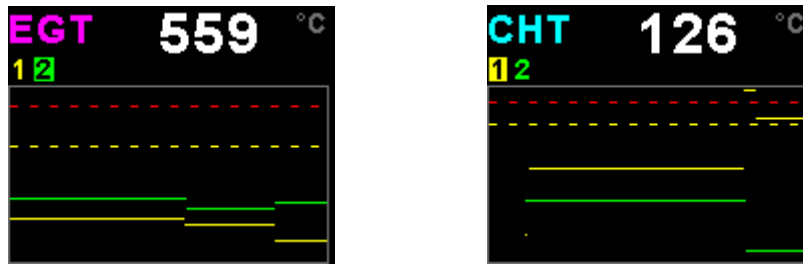

This display can be accessed by rotating the rotary control during the normal display mode. The trend graph displays the last 160 seconds of EGT/CHT temperature readings.

3.3 Maximum Values display

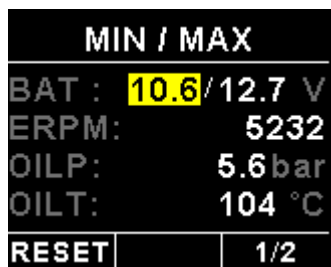

This display can be accessed by rotating the rotary control during the normal display mode. Press the F1/Up button when the max values display is showing to reset the maximum values.

Note: The maximum values are stored in non-volatile memory and are recalled on power-up.

3.4 Engine leaning mode

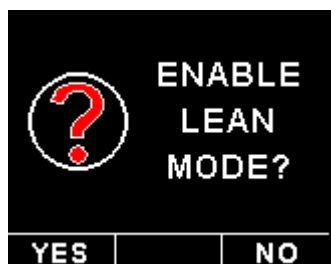

EGT information is also very useful for fuel mixture control. As the fuel mixture is leaned, so the exhaust gasses get hotter. This rise in temperature is a sign of increased combustion efficiency as the optimum mixture setting is approached. If the leaning progresses past a certain point however, the temperature will begin to drop. This temperature drop is the result of reduced energy output from the diminished fuel flow. The best operating mixture for aircraft engines is in the vicinity of this peak EGT reading. The EMS-1 has a special Leaning mode, which easily identifies the peak EGT condition allowing you to adjust your fuel mixture for best performance.

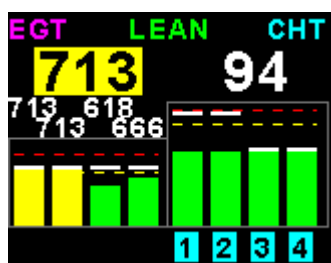

Fuel mixture should be adjusted once you have decided on a suitable cruise power setting (typically 70%). Press the F1/Up button on the main display to enable the engine leaning mode. The "LEAN" label is displayed at the top of the main display to clearly differentiate it from the normal operating mode.

As the fuel mixture is slowly leaned past the point at which the temperature begins to drop (by more than 10°C/15°F), the absolute EGT temperatures will change to show the EGT reading relative to this peak. The sequential order as each cylinder peaks is also shown.

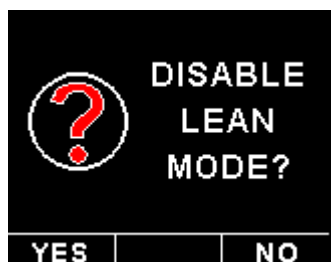

Leaning mode can be canceled by pressing the F1/Up button again.

3.5 Engine cruise mode

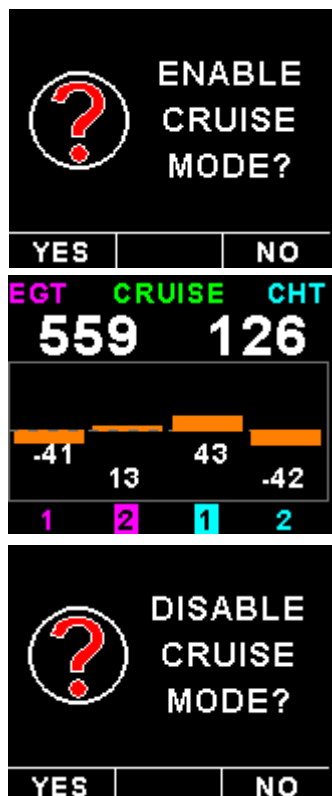

Once in the cruise, press the F2/Down button to enable the Cruise Mode. The "CRUISE" label is displayed at the top of the main display to clearly differentiate it from the normal operating mode. All EGT and CHT readings are immediately sampled as reference temperatures for the cruise.

The display then shows EGT and CHT values relative to this reference temperature.

Cruise mode can be canceled by pressing the F2/Down button again.

3.6 Magneto check function

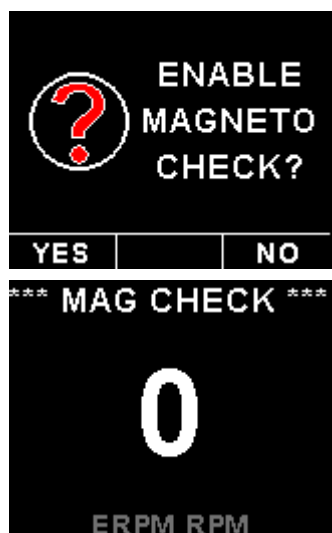

Press the F2/Down button once you have reached your normal run-up RPM. The display will show the RPM deviation from when the magneto function was activated. Any RPM drops will be displayed as a negative RPM value, a positive reading indicates an increase in RPM.

Switch the mag to left or right. The EMS-1 should display a negative (drop in) RPM. Then switch the mags to "Both". The EMS-1 reading should go back to zero or near zero. A problem should show up as an excessive drop in one mag and the return to zero or close to zero incorrectly.

The EMS-1 will return to the normal display after 60 seconds or if any key is pressed.

3.7 Start / Stop flight display



Press the F1/Up button during the normal display mode to manually start/stop a flight. This key is only active if the EMS-1 is setup to select the manual flight option under the "TIMERS" setup menu.

3.8 Enter starting level of the virtual calculated fuel tank



Press the F1 key during the main display screen to manually enter your current fuel level after fueling or defueling your aircraft. Press the F2 key as a “quick fill button” to the full level.

Note: It is good airmanship to take into account a “silent” fuel reserve. For example, if you have a 50 Litre tank and you fill it, enter 40 or 45 Litres as your available fuel.

4 Menu System

Press the rotary control button during the normal display mode to enter the menu system. Use the rotary control to navigate through the menu system.

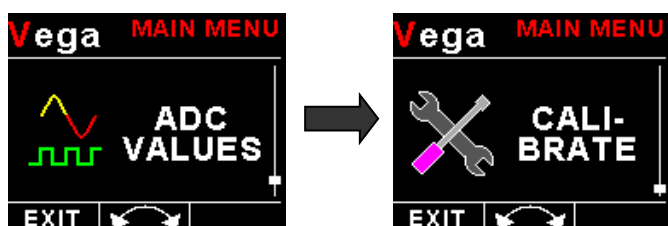
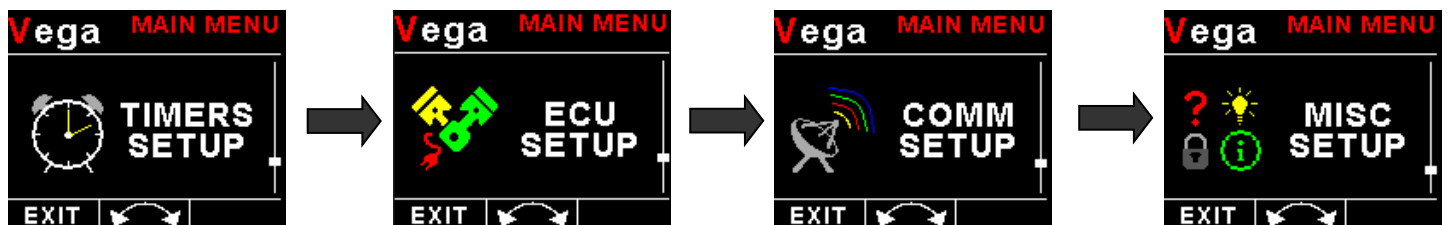
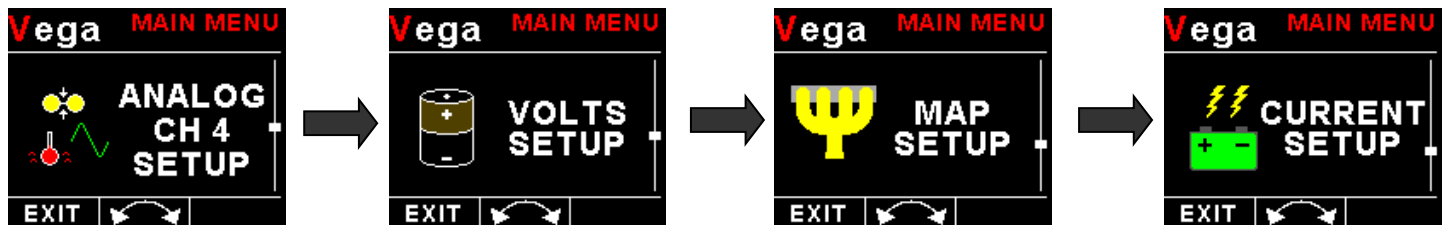
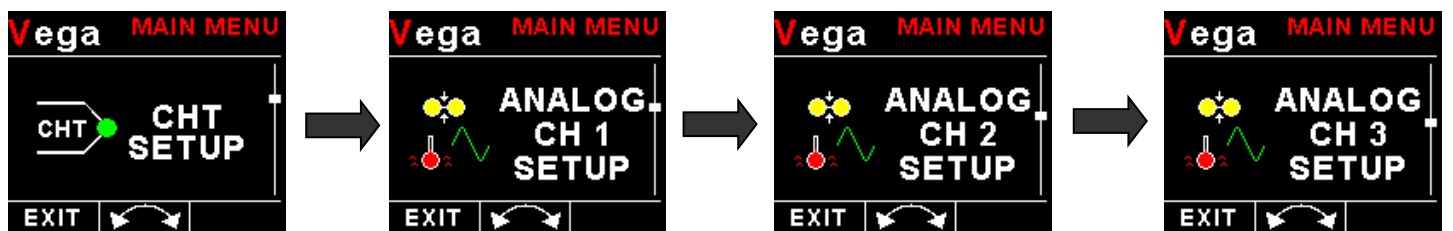
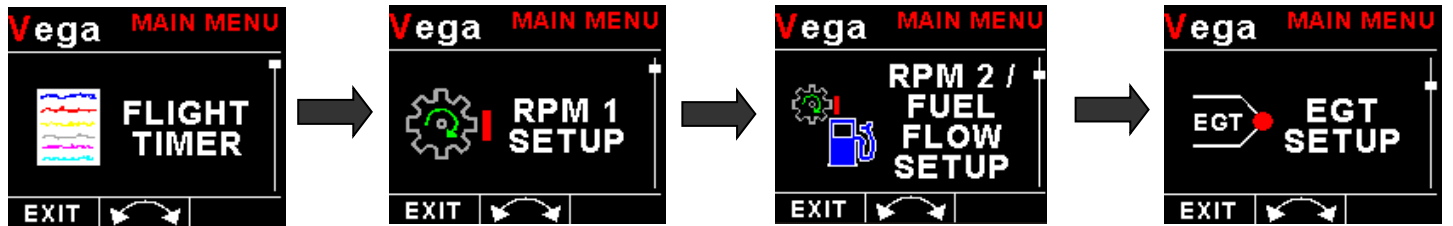

4.1 Exiting the menu system

Press the F1/Up button to exit the menu system when the “EXIT” soft key is shown. All changes made during navigation of the menu system will be saved in non-volatile memory upon exiting. The instrument will not save any changes if you remove power before exiting the menu system.

4.2 Flight Timer



View Flight Log:



Use the rotary control to view the next flight log entry.

Erase Flight Log:

Use this function to erase the flight log stored in the EMS-1.

FLIGHT:

Select whether you want the EMS-1 to automatically detect a flight or whether the pilot must press the F1/Up button to start/stop a flight. We recommend you select automatic flight detection either on RPM1 or RPM2.

T/O RPM:

This menu option is only shown if the “RPM1” or “RPM2” flight mode is selected. Enter the RPM take off threshold that you want the flight timer to start incrementing.

The flight ends if the RPM value falls below the preset value for 30 seconds.

4.3 RPM 1 Setup menu option

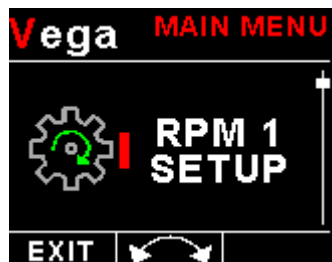

Display:

Select if you want the RPM to be displayed in "RPM", "PERCENT" or "OFF".

RPM 100%:

Select the maximum value that you want the RPM to correlate to 100%. This is only shown if "Percent" is selected for display.

Display Max:

Select the maximum RPM that you want the RPM dial to show. This can give you increased display resolution.

Display Min:

Select the minimum RPM that you want the RPM dial to show. This can give you increased display resolution.

High Alarm:

This enables or disables the RPM high alarm.

High Alarm:

Enter the RPM threshold for when the high alarm must be activated. Any RPM value above this value will activate the alarm.

High Caution:

Enter the RPM value for the high caution. This is the lower value of the upper yellow band.

Low Caution:

Enter the RPM value for the low caution. This is the upper value of the lower yellow band.

Low Alarm:

This enables or disables the RPM low alarm.

Low Alarm:

Enter the RPM threshold for when the low alarm must be activated. Any RPM value below this value will activate the alarm.

Pulses/Rev:

Enter the number of pulses per RPM. For engines with an uneven number of cylinders like three cylinder four stroke engines you can enter values containing fractions (usually 1.5 in this example). Most four stroke engines would generate one pulse for every two revolutions per cylinder. A four cylinder automotive four stroke engine would thus generate 2 pulses per revolution. A typical Rotax DCDI two stroke engine would generate 6 pulses per revolution. The well known Rotax 912/914 engine generates one pulse per revolution.

Increment:

Select the step size between successive RPM values eg. if the RPM value is 4003 RPM and the "RPM INCREMENT" is 5 then the actual value shown is 4005 RPM.

Label:

Enter a label to suit your channel so you can identify it easily.

Data:

Select the data source of the RPM signals. Options include internal (using the internal electronics within the EMS-1) or from an optional external RDAC unit.

RDAC Address:

Select the CAN address of the RDAC unit.

4.4 RPM 2 / Fuel Flow Setup menu option

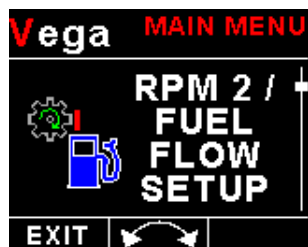

The RPM-2 input can be used for RPM or fuel flow.

If RPM is selected for “MODE”



Mode:

Select if you want to display “RPM2” or “FUEL FLOW” or “OFF”

Display:

Select if you want the RPM to be displayed in “RPM”, “PERCENT” or “OFF”.

RPM 100%:

Select the maximum value that you want the RPM to correlate to 100%. This is only shown if “Percent” is selected for display.

Display Max:

Select the maximum RPM that you want the RPM dial to show. This can give you increased display resolution.

Display Min:

Select the minimum RPM that you want the RPM dial to show. This can give you increased display resolution.

High Alarm:

This enables or disables the RPM high alarm.

High Alarm:

Enter the RPM threshold for when the high alarm must be activated. Any RPM value above this value will activate the alarm.

High Caution:

Enter the RPM value for the high caution. This is the lower value of the upper yellow band.

Low Caution:

Enter the RPM value for the low caution. This is the upper value of the lower yellow band.

Low Alarm:

This enables or disables the RPM low alarm.

Low Alarm:

Enter the RPM threshold for when the low alarm must be activated. Any RPM value below this value will activate the alarm.

Pulses/Rev:

Enter the number of pulses per RPM. For engines with an uneven number of cylinders like three cylinder four stroke engines you can enter values containing fractions (usually 1.5 in this example). Most four stroke engines would generate one pulse for every two revolutions per cylinder. A four cylinder automotive four stroke engine would thus generate 2 pulses per revolution. A typical Rotax DCDI two stroke engine would generate 6 pulses per revolution. The well known Rotax 912/914 engine generates one pulse per revolution.

Increment:

Select the step size between successive RPM values eg. if the RPM value is 4003 RPM and the “RPM INCREMENT” is 5 then the actual value shown is 4005 RPM.

Label:

Enter a label to suit your channel so you can identify it easily.

Data:

Select the data source of the RPM signals. Options include internal (using the internal electronics within the EMS-1) or from an optional external RDAC unit.

RDAC Address:

Select the CAN address of the RDAC unit.

If Fuel Flow is selected for “MODE”**Mode:**

Select if you want to display “RPM2” or “FUEL FLOW” or “OFF”

Unit:

Select if you want fuel flow displayed in L/Hr or G/Hr

Label:

Enter a label to suit your fuel flow input so you can identify it easily.

K-Factor:

The K-Factor is the number of pulses generated by the fuel flow sender for one Litre of fuel. The dual range fuel flow sender supplied by MGL Avionics has a K-Factor of 7000 in the low flow mode (jet installed) and 1330 for the high flow mode (no jet installed). You can use the K-Factor to calibrate your fuel flow sender. See the installation section for more details on how to calibrate and install the fuel flow sender.

Mode:

Select if you want to measure fuel flow using a fuel flow sender or by using fuel injectors.

Injector:

Select whether the EMS-1 fuel flow input is connected to the high or low side fired fuel injector.

Calc Tank Setup:

Select this menu item to setup the calculated fuel tank. See below.

Data:

Select the data source of the RPM signals. Options include internal (using the internal electronics within the EMS-1) or from an optional external RDAC unit.

RDAC Address:

Select the CAN address of the RDAC unit.

Calculated Tank Setup

FL **CALC** 45 L

**Calc Tank:**

Select if you want to enable or disable the calculated fuel tank.

Label:

Enter a label to easily identify your calculated fuel tank.

Litre Res:

Select the resolution of the Litre unit. 1L or 0.1L

Tank Size:

Enter the size of the fuel tank in your system. It is recommended to choose a size that is slightly less than actual size so you can compensate for sender inaccuracies and give you a measure of reserve fuel.

Low Alarm:

Enter your desired minimum fuel value that you would like to trigger the fuel low alarm. The fuel low alarm will result in the flashing of the fuel level display and remaining fuel readout. You can also connect a warning lamp to the external alarm output (see installation diagram). Note that the fuel low level will be displayed as a red bar on your fuel level display. This level is over and above your "silent" fuel reserve.

Low Caution:

Enter the fuel level value for your fuel caution. Note that the fuel caution level will be displayed as a yellow bar on your fuel level display.

Low Alarm:

Select whether to turn the fuel tank low level alarm on or off.

4.5 EGT / CHT Setup (Thermocouple Setup)



EGT / CHT Channels:

Select the number of EGT or CHT channels you want to use. Choices are from 1 to 4 (1 to 12 if using the optional RDAC). The temperature display will configure itself to make best possible use of the available display size. Please note that the minimum number of EGT & CHT channels that can be displayed is 1 and the maximum number of EGT and CHT channels that can be displayed is 4 (12 if using the optional RDAC).

Display:

A selection between "HIGHEST" or "SCANNING" can be selected. If "HIGHEST" is selected then the current highest thermocouple temperature is displayed. If "SCANNING" is selected then the unit will cycle through each thermocouple at a one second interval.

Display Max:

Select the maximum temperature that you want the EGT/CHT bargraph to show. This can give you increased display resolution.

Display Min:

Select the minimum temperature that you want the EGT/CHT bargraph to show. This can give you increased display resolution.

High Alarm:

This enables or disables the EGT/CHT high alarm.

High Alarm:

Enter the temperature threshold for when the high alarm must be activated. Any temperature above this value will activate the alarm.

High Caution:

Enter the temperature value for the high caution.

Probe:

Select if you are using a K-type, J-type or E-type thermocouple probe for this channel. All probes supplied by MGL Avionics are K-Type. J-types are sometimes used with American made CHT probes. All EGT probes are K-type. E-type probes are seldom used.

Temp Unit:

Select whether you want the temperature to be displayed in degrees Celsius (°C) or degrees Fahrenheit (°F).

Data:

Select the data source of the thermocouples. Options include internal (using the internal thermocouple amplifier and Vega connector) or from an optional external RDAC unit.

RDAC Address:

Select the CAN address of the external RDAC unit.

4.5.1 Special Rotax 912/914 probe mode

In this mode the Analog Channel 3 and Analog Channel 4 (or RDAC AUX 1 and AUX 2 analog input channels) become the Rotax CHT channel 1 and CHT channel 2 respectively. All CHT setups must still be done under the "CHT SETUP" menu.

4.6 Analog CH1 to CH4 Setup

The 4 analog channels are universal analog input channels that can be used for pressure, temperature, current, fuel level or as a generic analog input.

Only “CHANNEL 1” Setup is shown below, follow the same steps for Channel 2, 3 & 4

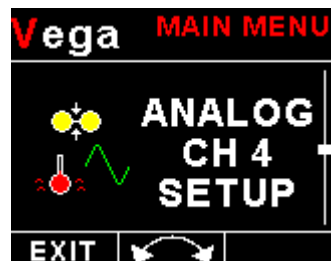
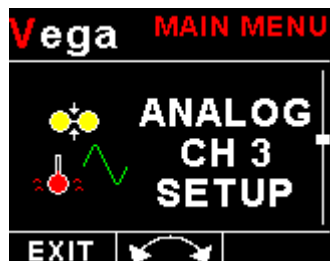
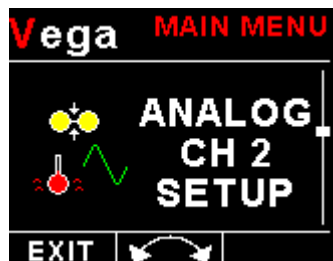
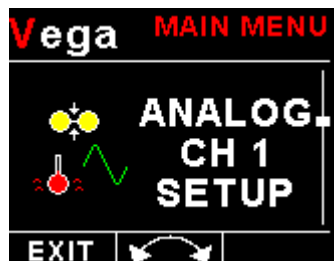

4.6.1 Pressure Setup

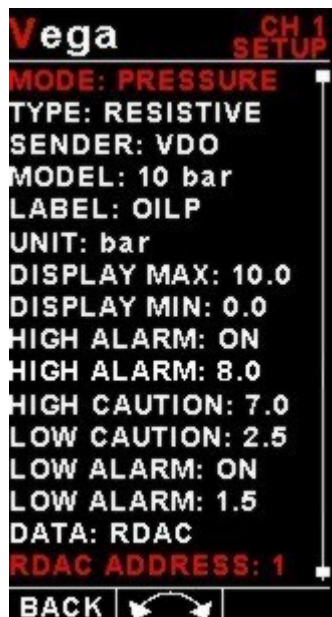

Mode:

Select the function for the analog channel. Options are "PRESSURE", "TEMP", "CURRENT", "FUEL LEVEL", "GENERIC" or "OFF".

Type:

Select if you are using a resistive, voltage or current pressure sender.

If the "RESISTIVE" pressure sender is selected

Sender:

Select what type of resistive pressure sender you are using. Select "VDO" for VDO / resistive senders, "USER" for a custom sender.

Model:

Select which VDO pressure sender you are using. A selection between a VDO 2, 5 or 10 Bar can be selected.

If the "VOLTAGE" pressure sender is selected

Sender:

Select the type of voltage sender you are using. Select "UMA" for UMA senders, "0.5-4.5V" for voltage senders, or "USER" for a custom voltage sender.

Model:

For UMA senders select the UMA model number.

If the "CURRENT" pressure sender is selected

Sender:

Select the type of current sender you are using. Select "4-20mA" for Rotax 912/914 4-20mA sender or "USER" for a custom 4-20mA sender.

Pressure @ 4mA:

Enter the pressure specified at 4mA output.

Pressure @ 20mA:

Enter the pressure specified at 20mA output.

Menu options for all sender types**If the “USER” pressure sender is selected****Calibrate Sender:**

If the sender type is set to “USER”, then use this menu option to calibrate your pressure sender. See section 4.6.3 for more information.

Label:

Enter a label to suit your pressure channel so you can identify it easily.

Unit:

Select whether you want to display the pressure in Bar, psi or psi(0.1). The psi(0.1) is for low range pressure senders e.g. UMA 7PSI.

Display Max:

Select the maximum pressure that you want the bargraph to show. This can give you increased display resolution.

Display Max:

Select the minimum pressure that you want the bargraph to show. This can give you increased display resolution.

High Alarm:

This enables or disables the pressure high alarm.

High Alarm:

Enter the pressure threshold for when the high alarm must be activated. Any pressure above this value will activate the alarm.

High Caution:

Enter the pressure value for the high caution. This is the lower value of the upper yellow band.

Low Caution:

Enter the pressure value for the low caution. This is the upper value of the lower yellow band.

Low Alarm:

This enables or disables the pressure low alarm.

Low Alarm:

Enter the pressure threshold for when the low alarm must be activated. Any pressure below this value will activate the alarm.

Data:

Select the data source of the pressure signal. Options include internal (using one of the analog channels within the EMS-1) or from an optional external RDAC unit.

RDAC Address:

Select the CAN address of the RDAC unit.

4.6.2 Temperature Setup

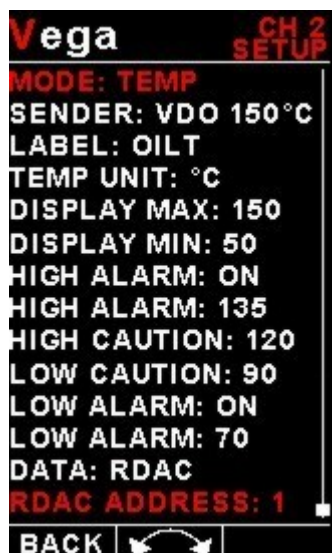

Mode:

Select the function for the analog channel. Options are "PRESSURE", "TEMP", "CURRENT", "FUEL LEVEL", "GENERIC" or "OFF".

Sender:

Select what type of sender you are using. Select "VDO 120" for a VDO 120 degree NTC sender, Select "VDO 150" for a VDO 150 degree NTC sender, "WESTACH" for Westach 339 NTC sender, "MGL" for a MGL NTC sender, "LM335" for a MGL precision temperature sender or "USER" for a custom sender.

If the sender type is set to "USER"

CALIBRATE SENDER:

If the sender type is set to "USER", then use this menu option to calibrate your pressure sender. See section 4.6.3 for more information.

If the sender type is set to "LM335"

LM335:

If the sender type is set to LM335, then use this menu option to calibrate your LM335 precision temperature sender. If recalibration is required then adjust the value until the temperature matches the reference ambient temperature. Please note that the LM335 can only be calibrated in degrees Celsius irrespective if the EMS-1 is setup to display temperature in Fahrenheit.

Menu options for all sender types

Label:

Enter a label to suit your temperature channel so you can identify it easily.

Temp Unit:

Select whether you want the temperature to be displayed in degrees Celcius (°C) or in degrees Fahrenheit (°F).

Display Max:

Select the maximum temperature that you want the bargraph to show. This can give you increased display resolution.

Display Min:

Select the minimum temperature that you want the bargraph to show. This can give you increased display resolution.

High Alarm:

This enables or disables the temperature high alarm.

High Alarm:

Enter the temperature threshold for when the high alarm must be activated. Any temperature above this value will activate the alarm.

High Caution:

Enter the temperature value for the high caution. This is the lower value of the upper yellow band.

Low Caution:

Enter the temperature value for the low caution. This is the upper value of the lower yellow band.

Low Alarm:

This enables or disables the temperature low alarm.

Low Alarm:

Enter the temperature threshold for when the low alarm must be activated. Any temperature below this value will activate the alarm.

Data:

Select the data source of the temperature signal. Options include internal (using one of the analog channels within the EMS-1) or from an optional external RDAC unit.

RDAC Address:

Select the CAN address of the RDAC unit.

4.6.3 Calibrating the user defined pressure, temperature and generic input senders

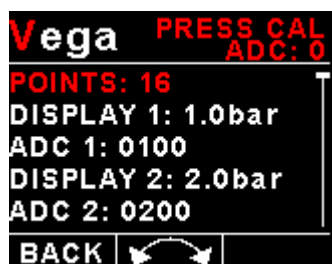

1. Enter the number of points that you want to calibrate.
2. Enter the display reading that you want to show when the sender is at that actual display reading.
3. Enter the ADC (analog to digital converter) reading that corresponds to this display reading. The ADC reading is shown at the top of the display if you are applying the actual stimulus from the temperature, pressure or current sender. You can also manually enter this value if the ADC value is known or pre-calculated.
4. Continue entering display and ADC values until all the points have been entered.
5. Verify the above calibration by checking the temperature, pressure or current display versus the actual applied sender stimulus.

4.6.4 Current Setup (requires a MGL Avionics Closed Loop Current Sensor)



Mode:

Select the function for the analog channel. Options are "PRESSURE", "TEMP", "CURRENT", "FUEL LEVEL", "GENERIC" or "OFF".

Label:

Enter a label to suit your current channel so you can identify it easily.

Display Max:

Select the maximum current that you want the bargraph to show. This can give you increased display resolution.

Display Min:

Select the minimum current that you want the bargraph to show. This can give you increased display resolution.

High Alarm:

This enables or disables the current high alarm.

High Alarm:

Enter the current threshold for when the high alarm must be activated. Any current above this value will activate the alarm.

High Caution:

Enter the current value for the high caution. This is the lower value of the upper yellow band.

Low Caution:

Enter the current value for the low caution. This is the upper value of the lower yellow band.

Low Alarm:

This enables or disables the current low alarm.

Low Alarm:

Enter the current threshold for when the low alarm must be activated. Any current below this value will activate the alarm.

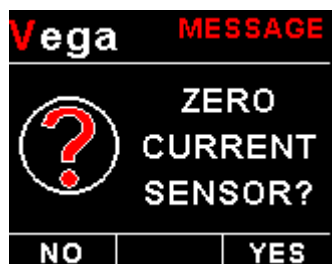
Zero Sensor:

Select this function to indicate to the EMS-1 that zero current is flowing through the MGL Avionics Closed Loop Current sensor. This is best done with the MGL Closed Loop Current sensor disconnected from the main current supplying conductor.

Gain:

Adjust the gain factor until the current is reading correctly. It will be best if a multimeter can be inserted in series with the current supplying conductor and the gain calibration adjusted until the EMS-1 matches that of the multimeter. Please see the MGL Avionics Closed Loop Current Sensor documentation for more information.

Data:

Select the data source of the current signal. Options include internal (using one of the analog channels within the EMS-1) or from an optional external RDAC unit.

RDAC Address:

Select the CAN address of the RDAC unit.

4.6.5 Fuel Level Setup



Mode:

Select the function for the analog channel. Options are “PRESSURE”, “TEMP”, “CURRENT”, “FUEL LEVEL”, “GENERIC” or “OFF”.

Label:

Enter a label to suit your fuel level channel so you can identify it easily.

Unit:

Select whether you want the fuel level to be displayed in Litres or in Gallons.

Litre Res:

Select the resolution of the Litre unit. 1L or 0.1L

Tank Size:

Enter the size of the fuel tank in your system. It is recommended to choose a size that is slightly less than actual size so you can compensate for sender inaccuracies and give you a measure of reserve fuel.

Low Alarm:

Enter your desired minimum fuel value that you would like to trigger the fuel low alarm. The fuel low alarm will result in the flashing of the fuel level display and remaining fuel readout. You can also connect a warning lamp to the external alarm output (see installation diagram). Note that the fuel low level will be displayed as a red bar on your fuel level display. This level is over and above your “silent” fuel reserve.

Low Caution:

Enter the fuel level value for your fuel caution. Note that the fuel caution level will be displayed as a yellow bar on your fuel level display.

Low Alarm:

Select whether to turn the fuel tank 1 low level alarm on or off.

Calibrate Tank:

See section 4.6.5.1 on how to calibrate the fuel level senders.

Tank Filter:

Select the damping factor for the fuel level. A selection of none, low, med or high can be made.

Data:

Select the data source of the current signal. Options include internal (using one of the analog channels within the EMS-1) or from an optional external RDAC unit.

RDAC Address:

Select the CAN address of the RDAC unit.

4.6.5.1 Calibrating the fuel level senders

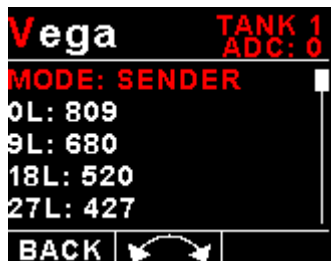

The fuel level sender needs to be calibrated before it can be used with this system. The calibration allows the system to learn the shape of your tank as well as any errors your fuel level sender or installation has.

Regardless of your use of a fuel flow sender, you can install a fuel level sender into your fuel tank. These level senders are inexpensive and are available as after market replacement fittings from a car spares outlet. We recommend the senders available from VDO.

Be aware that some makes of cheap level senders can prove troublesome, as the lever arms tend to be sticky. This prevents the floats from floating on the surface of the fuel at all times. As a consequence, this will lead to incorrect fuel level indication.

Adjusting calibration points automatically

Select “SENDER” for the mode menu item. Once you have installed a fuel level sender into your tank, make sure the float can travel all the way from empty to full position without hindrance of any kind. The calibration procedure should be carried out with your aircraft in flight attitude. This means you need to lift the tail if you have a tail-dragger or lift the nose wheel if you have a weight shift trike.

Calibration procedure

- Start the calibration procedure with an empty tank.
- Add five Litres of fuel (our reserve quantity) using a suitable measure. Make sure the measure is suitably accurate. This is now the “level sender reading at 0 Lt” position. Move the highlight to this position and wait until the sender reading has stabilized (You will see the sender ADC reading at the top). This could take up to a minute so have patience.

ENSURE THAT THE FLOAT IS NOT SUBMERGED AND IS FLOATING ON TOP OF THE FUEL LEVEL.

Should this number not react to changes of your level sender position, then you have a problem. Please check your wiring according to the installation section of this manual. You should expect the number to change in the region of at least 20 to 60 counts per calibration position. If the number does not change with fuel level or only changes a very small amount – check your installation. Something is not right!

- If you see the number changing then everything is well. Once it has stabilized and the highlight is on the 0 L position, press the rotary control to transfer the reading from the sender to the calibration point.
- Now you are ready for the next step. Add the required amount of fuel to get to the next level (In our case 9 Lt – this is 20% tank capacity). Once done, wait for the reading to stabilize and press the rotary control again after you have moved the highlight to the “9 L” position.
- Proceed in a similar manner until you have reached the last calibration position at 100% tank capacity.

You are done!

To finish your calibration, exit the calibration function.

The instrument uses the 6 calibration points to work out a correction curve that takes into account the tolerances of your fuel level sender and the shape of your fuel tank. This results in an incredibly accurate and usable fuel level display that far exceeds that available from ordinary dial type gauges.

Adjusting calibration points manually

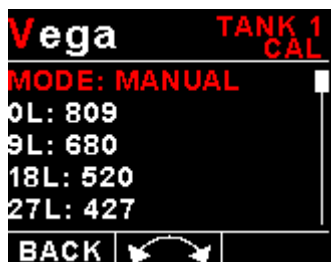

You may want to set individual calibration points manually. For example you may find that your fuel level is over reading at a specific fuel level. Correcting the tank level reading for this area can be simply done by adjusting the calibration point. You can do this by moving the float level with your hands to the desired position and then performing the calibration as outlined above, or you can use the manual option.

Select "MANUAL" for the mode menu item. Then highlight the point you want to change manually and press the rotary control. Use the up or down keys or the rotary control to adjust the value. Press the rotary control when done.

Note: The calibration positions may be edited by using the rotary control. This allows you, in theory, to copy calibration settings from one instrument to another. We however recommend that you do go through the calibration procedure even if the two aircraft are identical in all respects. Tolerances do exist and the calibration cancels these out. Accurate fuel level displays are a vital safety factor for an aircraft and a very useful feature for peace of mind during cross county flights.

Notes on Slope error



Sender value is a value determined by the EMS-1. It is used to calculate fuel level, fuel endurance estimate and current range estimate. The fuel tank setup sender value can either increase in value as fuel is added or decrease in value if fuel is added. This is dependent on the type of fuel level sender used. However should the second reading be larger than the first reading all readings will have to be larger than the previous readings. Likewise should the second reading be smaller than the first reading all readings will have to be smaller than the previous reading.

If this is not the case the wording "Slope error" will be displayed. This could happen when fuel was removed instead of added between steps, no fuel was added between steps or when the fuel level sender was moved in the wrong direction e.g. moving the fuel level sender manually when it is not inserted in to the fuel tank. Determine the cause of the error if you should get a slope error message. If you do not know the cause of your error it is best to start from scratch. It should be remembered that accuracy in the fuel tank calibration is extremely important to enable your EMS-1 to display the correct data.

4.6.6 Generic Analog Input Setup



Mode:

Select the function for the analog channel. Options are “PRESSURE”, “TEMP”, “CURRENT”, “FUEL LEVEL”, “GENERIC” or “OFF”.

Calibrate Sender:

Use this menu option to calibrate your generic analog input sender. See section 4.6.3 for more information. Use 2 points if the sensor is linear.

Label:

Enter a label to suit your generic analog input channel so you can identify it easily.

Unit Label:

Enter a unit label to suit your generic analog input channel.

Decimal Point:

Enter the decimal point position.

Display Max:

Select the maximum input that you want the bargraph to show. This can give you increased display resolution.

Display Min:

Select the minimum input that you want the bargraph to show. This can give you increased display resolution.

High Alarm:

This enables or disables the high alarm.

High Alarm:

Enter the threshold for when the high alarm must be activated. Any input above this value will activate the alarm.

High Caution:

Enter the input value for the high caution. This is the lower value of the upper yellow band.

Low Caution:

Enter the input value for the low caution. This is the upper value of the lower yellow band.

Low Alarm:

This enables or disables the low alarm.

Low Alarm:

Enter the threshold for when the low alarm must be activated. Any input below this value will activate the alarm.

Data:

Select the data source of the input signal. Options include internal (using one of the analog channels within the EMS-1) or from an optional external RDAC unit.

RDAC Address:

Select the CAN address of the RDAC unit.

4.7 Volts Setup



Display:

Select if you want the Volts to be displayed as a numeric only value at the top of the display or if you want to have it displayed as a bargraph. Select "OFF" to disable the volts display.

Label:

Enter a label to easily identify your Volts reading.

Display Max:

Select the maximum value that you want the volts bargraph to show. This can give you increased display resolution. The bargraph is only shown if the current display is disabled.

Display Min:

Select the minimum value that you want the volts bargraph to show. This can give you increased display resolution. The bargraph is only shown if the current display is disabled.

High Alarm:

This enables or disables the volts high alarm.

High Alarm:

Enter the voltage threshold for when the high alarm must be activated. Any voltage above this value will activate the alarm.

High Caution:

Enter the voltage for the high caution. This is the lower value of the upper yellow band.

Low Caution:

Enter the voltage for the low caution. This is the upper value of the lower yellow band.

Low Alarm:

This enables or disables the volts low alarm.

Low Alarm:

Enter the voltage threshold for when the low alarm must be activated. Any voltage below this value will activate the alarm.

Cal:

Measure the battery voltage with a multimeter and then adjust this value to match that of the multimeters volts reading.

4.8 MAP Setup (Manifold Setup)



Display:

Select if you want the MAP to be displayed as a numeric only value at the top of the display or if you want to have it displayed as a bargraph. Select "OFF" to disable the MAP display.

Label:

Enter a label to easily identify your MAP reading.

MAP Unit:

Select if you want the manifold pressure displayed in mB (millibars) or "Hg (inches of mercury).

Display Max:

Select the maximum pressure that you want the manifold bargraph to show. This can give you increased display resolution.

Display Min:

Select the minimum pressure that you want the manifold bargraph dial to show. This can give you increased display resolution.

High Alarm:

This enables or disables the manifold pressure high alarm.

High Alarm:

Enter the pressure threshold for when the high alarm must be activated. Any pressure above this value will activate the alarm.

High Caution:

Enter the pressure value for the high caution. This is the lower value of the upper yellow band.

Low Caution:

Enter the pressure value for the low caution. This is the upper value of the lower yellow band.

Low Alarm:

This enables or disables the manifold pressure low alarm.

Low Alarm:

Enter the pressure threshold for when the low alarm must be activated. Any pressure below this value will activate the alarm.

Filter:

This function can be used to select the signal filter time constant. Selections are "NONE", "FAST" or "SLOW". This selection influences the rate at which your manifold pressure can change its reading.

Cal:

The sender in the RDAC is shipped uncalibrated. To calibrate the manifold pressure, compare and adjust the calibration factor until the manifold reading is the same as the barometric pressure. The manifold pressure can only be calibrated in mB.

RDAC Address:

Select the CAN address of the RDAC unit.

4.9 Current Setup (MGL Avionics Closed Loop Current Sensor and RDAC required)

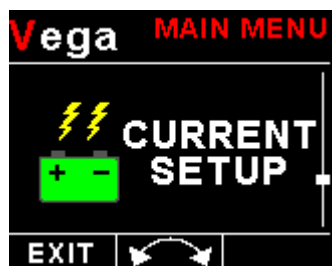

Display:

Select to enable or disable the RDAC current display.

Label:

Enter a label to easily identify your Current reading.

High Alarm:

This enables or disables the current high alarm.

High Alarm:

Enter the current threshold for when the high alarm must be activated. Any current above this value will activate the alarm.

High Caution:

Enter the current value for the high caution.

Low Caution:

Enter the current value for the low caution.

Low Alarm:

This enables or disables the current low alarm.

Low Alarm:

Enter the current threshold for when the low alarm must be activated. Any current below this value will activate the alarm.

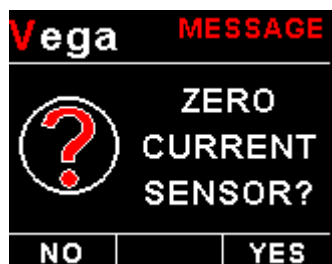
Zero Sensor:

Select this function to indicate to the EMS-1 that zero current is flowing through the MGL Avionics Closed Loop Current sensor. This is best done with the MGL Closed Loop Current sensor disconnected from the main current supplying conductor.

Gain:

Adjust the gain factor until the current is reading correctly. It will be best if a multimeter can be inserted in series with the current supplying conductor and the gain calibration adjusted until the EMS-1 matches that of the multimeter. Please see the MGL Avionics Closed Loop Current Sensor documentation for more information.

RDAC Address:

Select the CAN address of the RDAC unit.

4.10 Timers Setup



Set UTC Time:



This function is used to set the internal real time clock. The time to be entered must be UTC in order for the system to operate correctly. Do not enter local time (unless it is the same as UTC).

UTC is the same as Greenwich Mean Time (GMT) or Zulu time.

UTC Offset:

Enter the UTC offset for your location. The UTC offset can be adjusted in half an hour increments.

RTC Trim:

This allows you to adjust a trimming factor that will increase the accuracy of the built in clock. Increasing the trim value will result in the slowing down of the time.

SET HOBBS TIME:



This function allows you to set the engine Hobbs meter to any value. Typically, you would use this function to set the Hobbs meter to the current known engine time. Use the rotary control to change the value. Press the rotary control to accept and exit the menu option. If the Hobbs code is set to another value beside zero, then the pilot will be prompted to enter the Hobbs access code before allowing him to change the Hobbs time. This feature is useful for chartered and flying school planes.

HOBBS CODE:

This menu option allows you to change the Hobbs access code. You will first be prompted to enter the current code followed by entering in a new code followed by re-entering the new code. If the new code and the re-entered code is the same, then the Hobbs access code will be changed. Default code is 0000.

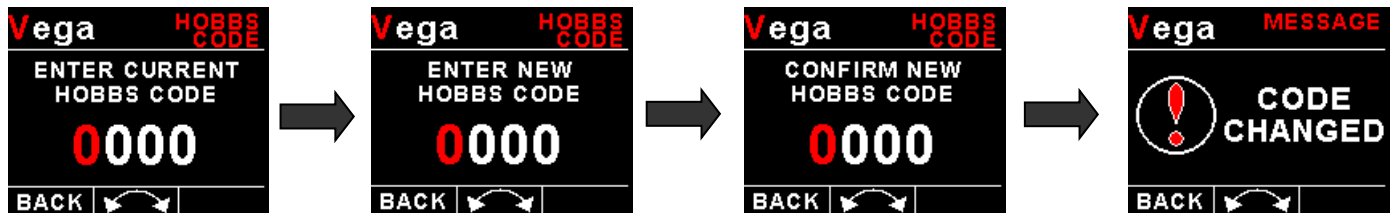

HOBBS HOUR:

Select if you would like the hour to be displayed in decimal fractions or minutes.

SET MAINT TIME:

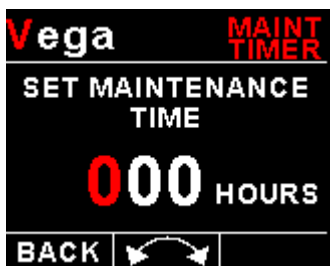

This function allows you to set an engine maintenance timer. This timer is set in engine hours and it will count down to zero when the engine RPM is greater than the "HOBBS RPM". A good use for this function is to set the hours until your next spark plug change or engine inspection. Use the rotary control to change the value.

H/M Start:

Select what source will start the Hobbs and Maintenance timers. A selection between Power, RPM 1 or RPM 2 can be made.

HOBBS RPM:

Enter the RPM limit in which the Hobbs timer/Maintenance timer must start incrementing.

4.11 ECU Setup (Engine Control Unit)

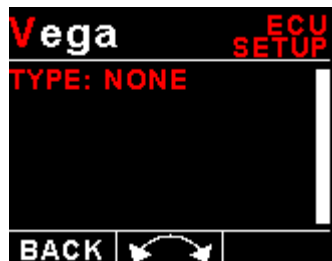

Type:

Select the ECU type that is connected to the EMS-1. Select "NONE" for standard EMS-1 or no RDAC functionality, "ROTAX 91XiS" or "UL POWER".

4.11.1 ROTAX 91XiS (912is or 915is) Setup

The ROTAX 912iS / 915iS ECU can be connected to the EMS-1 either by direct connection or by using the MGL Avionics RDAC CAN 912iS.



Connect:

Select if the ROTAX 91XiS ECU is connected to the EMS-1 by direct connection or by using the MGL Avionics RDAC CAN 912iS.

Lane: (Direct connection only)

Select the lane that you want the data to be displayed from.

The ROTAX 91XiS ECU Oil temperature is mapped to the EMS-1 Analog CH 1 (renamed to Oil Temp Setup), ROTAX 91XiS ECU Oil Pressure to the EMS-1 Analog CH 2 (renamed to Oil Press Setup) and the ROTAX 91XiS ECU Coolant temperature to the EMS-1 Analog CH 3 (renamed to Coolant Temp Setup). These channels need to be setup accordingly.

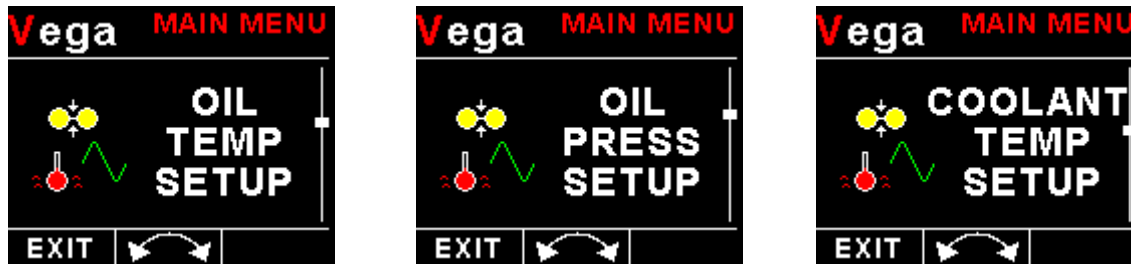

The ROTAX ECU transmits various status messages. These can be observed in the ROTAX 91XiS main display pages,

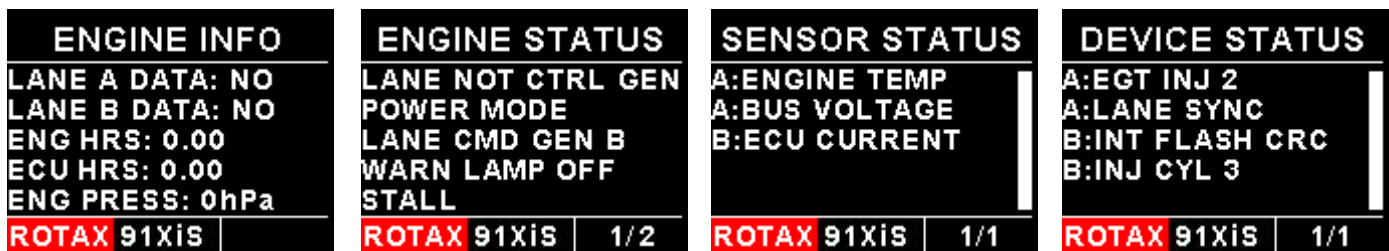

ROTAX 912iS / 915iS Direct Connection

The EMS-1 can be connected directly to the ROTAX 912iS / 915iS ECU.

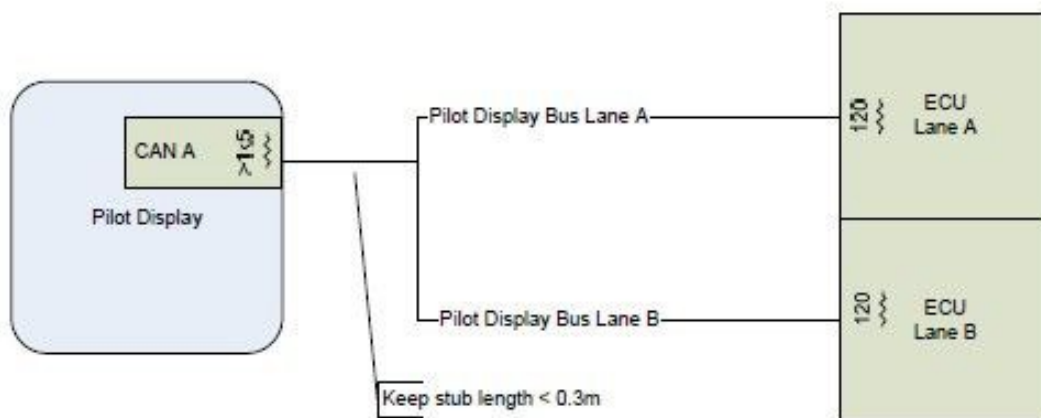

As shown on this diagram, connect the CAN bus ECU lanes A and B together and then connect to the EMS-1 CAN inputs.

Do NOT add CAN termination resistors to this connection as both ECUs have these built in.

RDAC CAN ROTAX 912iS Connection

The EMS-1 can also be connected to the ROTAX 912iS / 915iS ECU via the MGL Avionics RDAC CAN.

Please see the RDAC CAN 912iS documentation for installation and usage. If using the RDAC CAN ROTAX 912iS then the EMS-1 needs to be setup as below.

RPM 1:

PULSES/REV: 1.0
DATA: RDAC

RPM 2 / Fuel Flow:

MODE: FUEL FLOW
K-FACTOR: 7000
MODE: FF SENDER
DATA: RDAC

Manifold Air Pressure:

CAL: 0

Oil Temperature (Analog Channel 1):

FUNCTION: TEMP
SENDER: LM335
CAL: 0
DATA: RDAC

Oil Pressure (Analog Channel 2):

FUNCTION: PRESSURE
TYPE: RESISTIVE
SENDER: USER
CALIBRATE SENDER:
POINTS: 2
DISPLAY 1: 0.0 bar
ADC 1: 0000
DISPLAY 2: 10.0 bar
ADC 2: 4095
DATA: RDAC

Coolant Temperature (Analog Channel 3):

FUNCTION: TEMP
SENDER: LM335
CAL: 0
DATA: RDAC

EGT 1,2,3,4

EGT CHANNELS: 4
DATA: RDAC

Throttle Position:

0-100% is displayed as a bar graph

Engine Ambient Pressure:

This can be viewed in the Engine Info display screen

Fuel Level sender (MGL Avionics RDAC CAN FL2 mapped to EMS-1 Analog Channel 4):

This is setup as normal in the analog setup menu

DC current input:

This is setup as normal in the current setup menu.



ROTAX 912iS recommended settings:**Engine RPM:**

0 to 1500 RPM: Red
1500 to 1800 RPM: Yellow
1800 to 5500 RPM: Green
>5800 RPM: Red

MAP:

0 to 200 mBar: Yellow
200 to 1100 mBar: Green
1100 to 1150 mBar: Yellow
>1150 mBar: Red

Oil Pressure:

0 to 1.5 Bar: Red
1.5 to 3.0 Bar: Yellow
3.0 to 5.0 Bar: Green
5.0 to 7.0 Bar: Yellow
>7 Bar: Red

Oil Temperature:

<50 °C: Yellow
50 to 110 °C: Green
110 to 130 °C: Yellow
>130 °C: Red

Fuel Pressure:

0 to 2.6 Bar: Red
2.6 to 2.7 Bar: Yellow
2.7 to 3.5 Bar: Green
3.5 to 3.8 Bar: Yellow
>3.8 Bar: Red

Coolant Temperature:

<50 °C: Yellow
50 to 110 °C: Green
110 to 120 °C: Yellow
>120 °C: Red

EGT Temperature:

<900°C: Green
900 to 950 °C: Yellow
>950 °C: Red

4.11.2 UL Power ECU

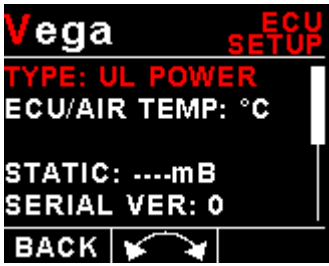

Connect the UL Power Engine to the EMS-1 RS232 port using the UL Power cable E080305 (RS232-EFIS cable).

ECU/AIR TEMP (ULPower ECU only):

Select whether you want the temperature to be displayed in degrees Celcius (°C) or in degrees Fahrenheit (°F).

ULPower display screen

A dedicated display screen will be shown when the UL Power is selected for the ECU type.

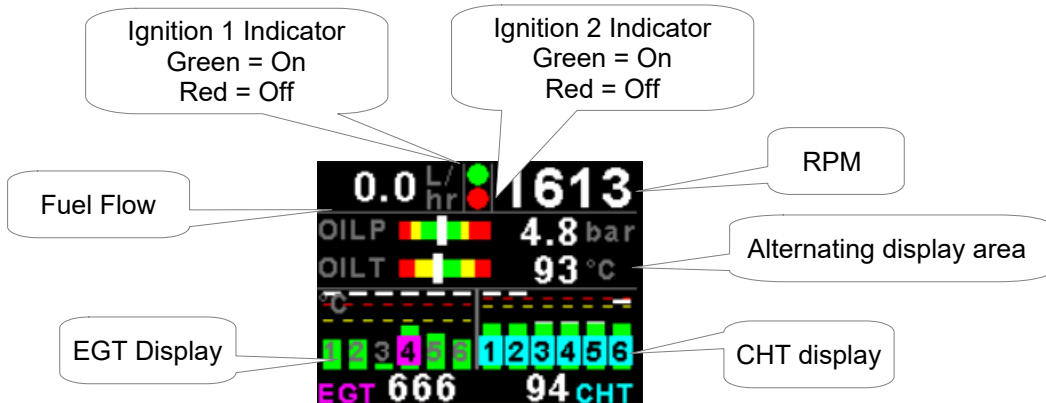

Alternating Display Area

Oil pressure, Oil Temperature, Fuel Pressure, OAT, Throttle position, ECU temperature, air temperature, Volts and optional current is displayed here.



Warning Messages from the ULPower ECU



The ULPower ECU Oil Pressure is mapped to the EMS-1 Analog CH 1 (renamed to Oil Press Setup), the ULPower ECU Oil Temperature to the EMS-1 Analog CH 2 (renamed to Oil Temp Setup) and the ULPower ECU Fuel Pressure to the EMS-1 Analog CH3 (renamed to Fuel Press Setup). These channels need to be setup accordingly.

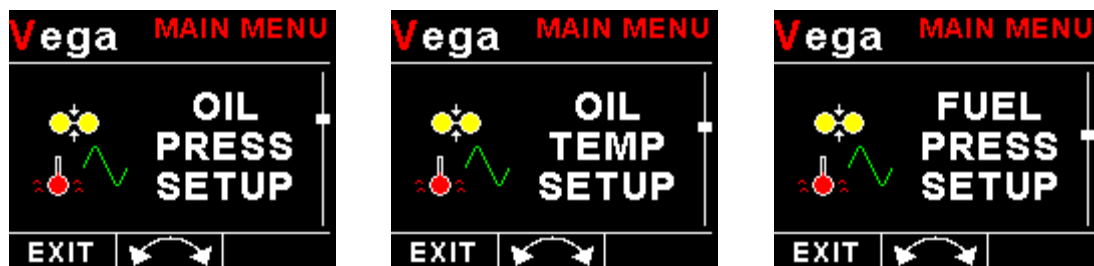

The MGL Avionics RDAC can be used to measure CHT, EGT and MAP. The EMS-1 also supports the ULPower Aux box

ULPower recommended settings:

- Oil Pressure: max 8 bar (115psi) - normal 2 to 5 bar (30 – 75 psi) above 2000rpm - minimum 0.7 bar
- Oil Temperature: Max 120°C (248°F) - Min 50°C (122°F) - Normal between 80°C and 100 °C (175°F – 212°F)
- Fuel Pressure: max 3.8 bar (55psi) - normal 3 bar (43,5 psi) - minimum 2.4 bar (35 psi)
- Map: Max 1.1 bar (33 inch/kg) – Min. 0.3 bar (9 inch/kg)
- EGT: max 860°C (1580°F) - Min. 400°C (700°F) - Normal between 700°C and 800°C (129°F – 1470°F)
- CHT: max 180°C (356F°) - Max. continuous 160°C (320°F) - Min. 50°C (125°F)

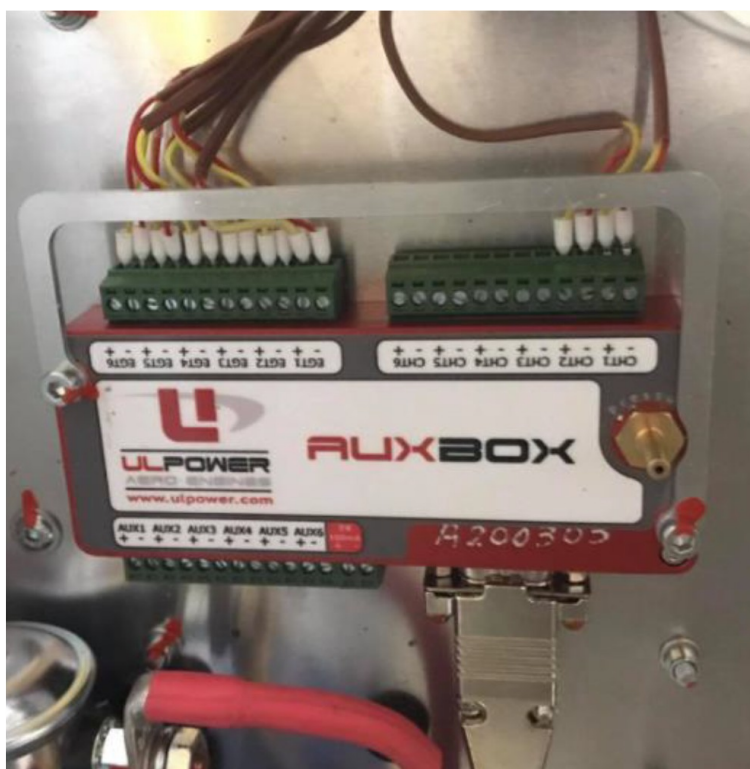

4.12 COMM Setup (Communication Setup)



Serial Out:

Select "ON" to enable the RS232 serial output.

Unit Address:

Enter the EMS-1 unit address.

Baud Rate:

Select the desired baud rate of the serial output.

The transmission format is set to 8 data bits, No parity, 1 stop bit. The baud rate can be changed in the Communication Menu.

4.12.1 Protocol Format

STX, Address, Message type, Length, Data payload, Checksum, ETX

STX: Start of text (0x02)

Address: unsigned char (8bit), Unit address (range 0-255)

Message Type: unsigned char (8bit), Specifies the message type

Length: unsigned char (8bit), Length of the data payload (does not include the STX, Address, message type, checksum or ETX)

Data payload: Data

Checksum: unsigned char (8bit), XOR of all bytes starting from the unit address to the end of the data payload. The checksum is seeded with 0xa5. (does not include the STX or ETX)

ETX: End of text (0x03)

4.12.2 Data payload

Message type=1

Data Length=67 bytes

Output Rate=1Hz

Unused channels will read 0

Local Time: Unsigned Long (32 bit), Time is seconds since 1 January 1970

Hobbs Hours: Unsigned Int (16 bits), Hobbs hours

Hobbs Minutes: Unsigned char (8 bits), Hobbs minutes

Maintenance Time: Unsigned Int (16 bits), Maintenance time in hours

Volts: Unsigned Int (16 bits), Volts in 0.1V

RPM 1: Unsigned Long (32 bit), RPM 1 value

RPM 1 (%): Unsigned Int (16 bit), RPM 1 value in percentage

RPM 2: Unsigned Long (32 bit), RPM 2 value

RPM 2 (%): Unsigned Int (16 bit), RPM 2 value in percentage

Analog Channel Type: Unsigned Int (16 bits)

CH4 (4 bits), CH3 (4 bits), CH2 (4 bits), CH1 (4 bits)

0=Off

1=Pressure

2=Temperature

3=Current

4=Fuel Level

5=Generic

Analog Channel 1: Signed Int (16 bits)

Pressure in 0.1psi

Temperature in Degrees C

Current in 0.1A

Fuel Level in Liters

Generic in user units

Analog Channel 2: Signed Int (16 bits)

Pressure in 0.1psi

Temperature in Degrees C

Current in 0.1A

Fuel Level in Liters

Generic in user units

Analog Channel 3: Signed Int (16 bits)

Pressure in 0.1psi

Temperature in Degrees C

Current in 0.1A

	Fuel Level in Liters
	Generic in user units
Analog Channel 4:	Signed Int (16 bits)
	Pressure in 0.1psi
	Temperature in Degrees C
	Current in 0.1A
	Fuel Level in Liters
	Generic in user units
Manifold Pressure:	Signed Int (16 bits), Manifold pressure in mBar
Current:	Signed Int (16 bits), Current in 0.1A
CJC:	Signed Int (16 bit), Cold junction temperature in Degrees Celsius
TC1:	Signed Int (16 bit), Thermocouple channel 1 in Degrees Celsius
TC2:	Signed Int (16 bit), Thermocouple channel 2 in Degrees Celsius
TC3:	Signed Int (16 bit), Thermocouple channel 3 in Degrees Celsius
TC4:	Signed Int (16 bit), Thermocouple channel 4 in Degrees Celsius
TC5:	Signed Int (16 bit), Thermocouple channel 5 in Degrees Celsius
TC6:	Signed Int (16 bit), Thermocouple channel 6 in Degrees Celsius
TC7:	Signed Int (16 bit), Thermocouple channel 7 in Degrees Celsius
TC8:	Signed Int (16 bit), Thermocouple channel 8 in Degrees Celsius
TC9:	Signed Int (16 bit), Thermocouple channel 9 in Degrees Celsius
TC10:	Signed Int (16 bit), Thermocouple channel 10 in Degrees Celsius
TC11:	Signed Int (16 bit), Thermocouple channel 11 in Degrees Celsius
TC12:	Signed Int (16 bit), Thermocouple channel 12 in Degrees Celsius
Fuel flow:	Unsigned Int (16 bits), Fuel Flow in 0.1Liters per Hour
Calculated fuel level:	Unsigned Int (16 bits), Calculated fuel Level in Liters

4.13 MISC Setup (Miscellaneous Setup)

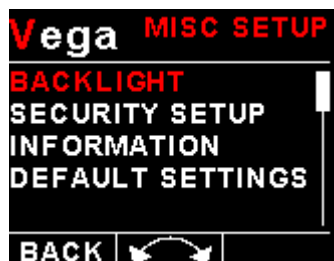

Backlight:

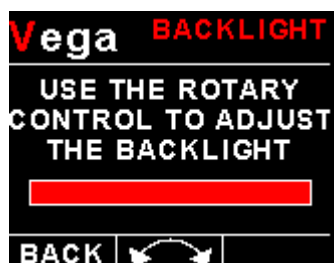

Select this menu option to adjust the backlight brightness.

Security Setup:



Select this menu option if you want to password protect the menu system.

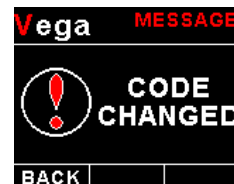
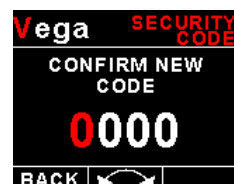
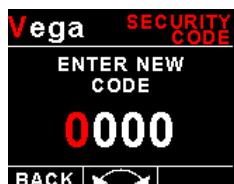

Information:

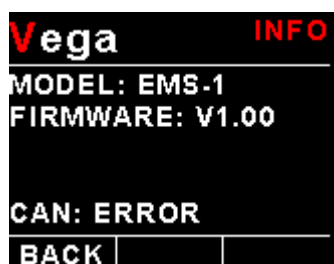

This menu option displays information about the unit.

Default Settings:

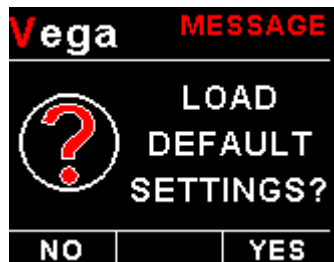

Select this menu option to reset all the settings to factory defaults.

4.14 ADC Values

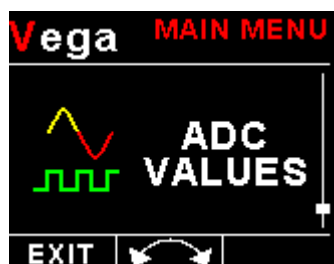

This menu displays the ADC values of the various sensors.

5 Loading factory default settings



Press and hold the F1/Up button and rotary control during power up to load the pre-programmed factory default settings. The following screen will be displayed:

Factory default settings can also be loaded in the Miscellaneous setup menu.

6 Error Messages



Unit settings CRC error. Load default settings to restore to factory defaults. If the error message still persists then it could possibly be a non-volatile memory failure in which case the instrument will then have to be returned to the factory.



Internal flash CRC error. The instrument does a firmware check on the program when power is applied to the instrument . If the program is corrupt in any way then the internal flash CRC error will be displayed. Reload the instruments firmware and load default settings. If the error message still persists then it could possibly be an internal flash memory failure in which case the instrument will then have to be returned to the factory.



Hobbs / Maintenance Timer CRC error. Try entering new values for the Hobbs meter and Maintenance timer and see if the error message disappears. If the error message still persists then it could possibly be a non-volatile memory failure in which case the instrument will then have to be returned to the factory.



Calibration constants CRC error. The instrument could possibly have a non-volatile memory failure in which case the instrument will then have to be returned to the factory.



Max Values CRC error. Load default settings to restore to factory defaults. If the error message still persists then it could possibly be a non-volatile memory failure in which case the instrument will then have to be returned to the factory.

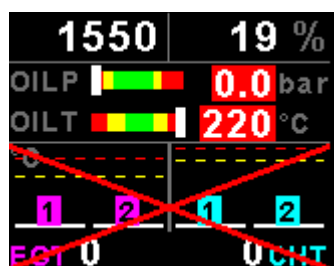

The red cross over the display means the EMS-1 has lost communications with the external RDAC unit. Check the wiring between the EMS-1 instrument and the RDAC unit. This error message is only available when the external RDAC is selected as the data source.

7 Specifications

Operating Temperature Range	-20°C to 50°C (-4°F to 122°F)
Storage Temperature Range	-30°C to 80°C (-22°F to 176°F)
Power Supply	8 to 30Vdc
Current Consumption	Approx. 80mA @ 13.8V (backlight highest setting), 36mA @13.8V (backlight lowest setting)
Display	1.8" 160x128 pixel active matrix TFT display. 1000 cd/m ² Sunlight readable with anti-glare coating LED Backlight is user configurable
Alarm Output	Open collector transistor switch to ground Maximum rating 0.25A
ADC	12 bit
Dimensions	see Vega series dimensional drawing
Enclosure	2 1/4" (57mm) ABS, black in color, front or rear mounting. Flame retardant.
Weight	Approx. 120 grams (Instrument excluding cables)
Non-volatile memory storage	100000 write cycles
RPM Inputs	
RPM input 1	Range: 0-99999 RPM. Minimum signal for stable display: 5Vpp. Fully A/C coupled, maximum voltage +/- 40V. RF noise filter plus Schmitt trigger based input
RPM input 2	Range: 0-99999 RPM. TTL level input Required input voltage swing: less than 1.5V to more than 3.5V. Maximum input voltage range -5V to +18V RF noise filter and Schmitt-trigger based input.
Sensor Output Voltage	+5Vdc. Max 50mA
Fuel Flow Input	
Fuel Flow input	RF noise filter plus Schmitt trigger based input External pull up resistor may be required
Sensor Output Voltage	+5Vdc. Max 50mA
Thermocouples	
Type	J-type, K-type and E-Type
Measurement range	EMS-1 Internal amplifier K-Type: -100°C to 1200°C (-148°F to 2192°F) J-Type: -100°C to 1100°C (-148°F to 2012°F) E-Type: -100°C to 800°C (-148°F to 1472°F)
Technology	Fully cold junction compensated using a precision internal temperature reference and built in thermocouple linearization tables
Measurement accuracy	+/- 5 degrees typical over full temperature range, subject to quality of probe used. We recommend MGL Avionics EGT and CHT probes
Inputs	Differential, can use grounded and isolated probes
Common mode voltage range	-2V to +3V
Channels	4 using the internal electronics, 12 using the optional external RDAC
Analog Input Channels	
Analog Input Channels	4 Total. 3 (With dipswitch programmable pullup resistor), 1(With fixed pull up resistor)

Pressure Sender Input	
Pressure Sensors	<p>VDO Resistive Sender: The EMS-1 supports the VDO 2, 5 and 10 Bar senders. VDO pressure senders used to measure fuel pressure require the fuel isolation kit available from VDO.</p> <p>Rotax 4-20mA Sender: The EMS-1 supports the 4-20mA pressure sender as used in Rotax 912/914 engines.</p> <p>Voltage Output Pressure Senders: e.g. UMA senders that output a voltage signal. A 0.5-4.5V sender selection is also available.</p> <p>UMA N/T 1EU07G(M): 7PSI (0.5Bar) for carbureted engine (Rotax) UMA N/T 1EU35G(M): 35PSI (2.4Bar) for carbureted engine (Lycoming/Continental) UMA N/T 1EU100G(M): 100PSI (6.9Bar) for injected (Lycoming / Continental) (M) is MGL modified senders</p> <p>The EMS-1 includes linearisation curves for the UMA N/T 1EU07, N/T 1EU35, N/T 1EU70, N/T 1EU70A, N/T 1EU100 and N/T 1EU150 pressure senders</p> <p>User defined senders: EMS-1 has a user sender calibration feature that can be customized for senders not listed above.</p>
Temperature Sender Input	
Temperature Sensors	<p>VDO Resistive Senders: VDO 120°C and VDO 150°C thermistor senders supported.</p> <p>MGL NTC Resistive Sender: Echlin TS920SA (32040) automotive temperature sender</p> <p>MGL Precision LM335 semiconductor: Based on STMicroelectronics LM335 temperature sensor</p> <p>Westach Resistive Senders: Westach 399 thermistor series temperature senders.</p> <p>User defined senders: The EMS-1 has a user sender calibration feature that can be customized for senders not listed above</p>
Fuel Level Sender Input	
Fuel level input	Maximum voltage: 5V, 5mA maximum current
Fuel level senders supported	<p>Any resistive type with common ground and capacitive probes with active voltage outputs up to 5V level (push pull or pull up).</p> <p>The analog channel dip switch should be disabled and an external 1k resistor should be connected between the fuel level input and the +5V sensor power</p>
Analog channel input pull up resistor	1k5 (Can be disabled via the internal dip switches)

Current Sensor	
Current Sensors	MGL Avionics Closed Loop Current Sensor
Volts	
Voltage measurement range	Up to 32Vdc
Voltage resolution	0.1V
OAT Probe	
OAT Temperature Sender type	Semiconductor LM335 (STMicroelectronics)
RTC	
Internal battery type	CR2032

8 Operating the alarms

The alarm output can be used to switch an external alarm indicator. The external alarm switch is an open collector transistor switch to ground with a maximum rating of 0.25A DC. It is possible to wire the alarm contacts of several Stratomaster instruments in parallel should this be desired. To avoid false activation of the alarms, the alarm function is only active 10 seconds after the instrument has powered up.

9 Firmware Upgrading

The EMS-1 can be upgraded in the field by connecting the RS232 port to a PC and running the firmware update program. **Note that only the RS232 port can be used to upgrade the firmware.**

Please see the Vega firmware upgrading document for more information.

10 Changing the internal battery

The EMS-1 uses an internal battery to supply power to the clock. You will need to replace the internal battery if you find the EMS-1 loses time when you switch off the main power. This battery is of type CR2032. It is used in many calculators and similar equipment and is easy to obtain. Remove the 2 securing nuts next to the D15 connector and remove the unit from its enclosure. The battery holder is located on the circuit board behind the display. Observe correct polarity when installing a new battery. The side marked "+" will be viewable once the battery is inserted.

11 Installation

11.1 Connection Diagram

The use of an external 1A fuse is recommended. Connect the supply terminals to your aircraft's power supply. The EMS-1 can be used on both 12V and 24V without the use of any pre-regulators. Ensure that the supply voltage will not drop below 8V during operation as this may result in incorrect readings.

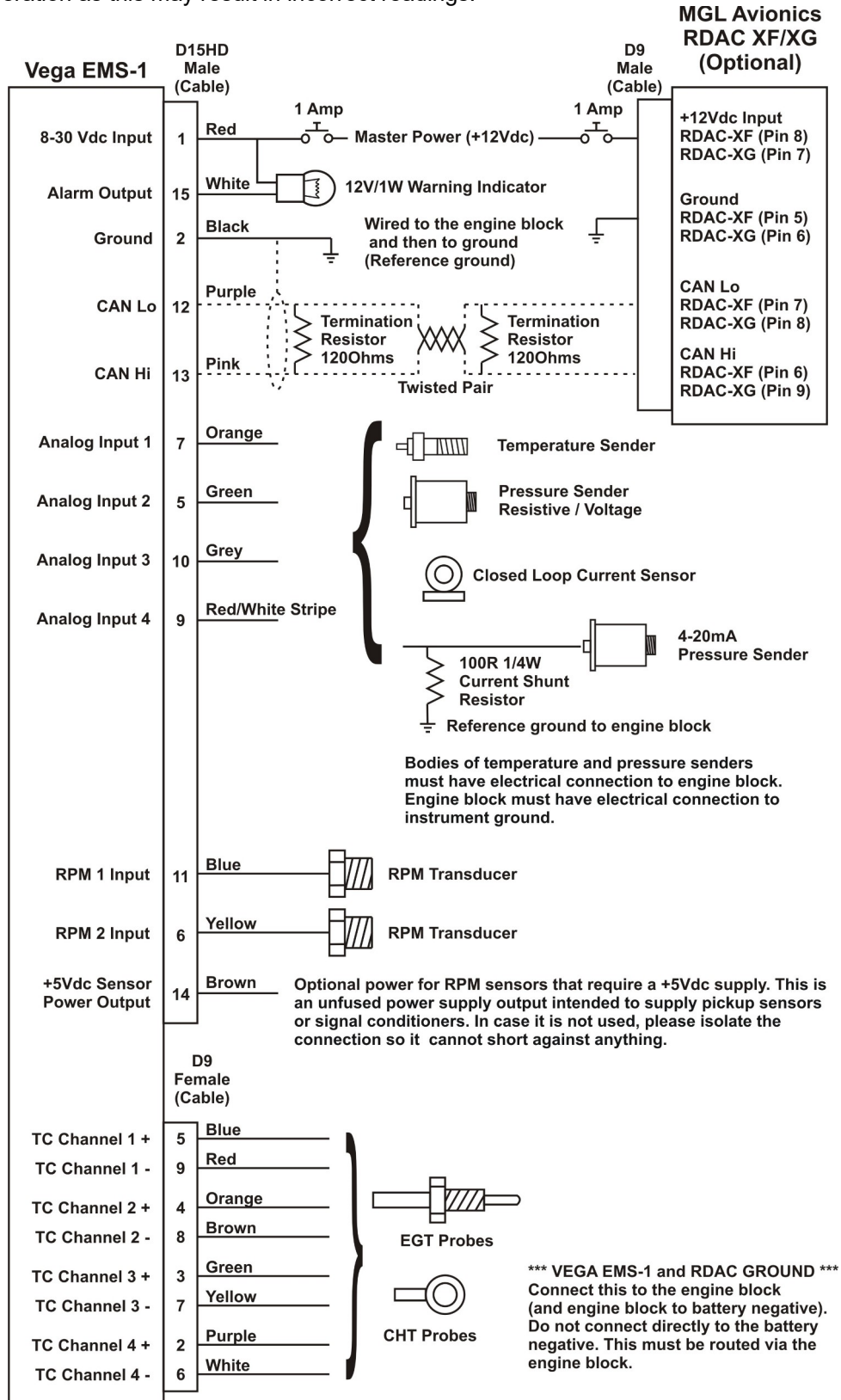

Please note: The +5V Sensor power output line is unprotected and intended only for the supply of a hall-effect, optical or gear tooth sensors. Connecting any voltages (such as the 12V supply) to this line could destroy the instrument. The +5V line may supply currents of up to 50mA. Should your sensor require greater currents you must supply it from another source.

Please note: It is essential that a single wire be connected from the minus terminal of the instrument to the engine block. This wire must not be used to share currents with other electrical users as this can affect accuracy of readings.

11.2 EGT/CHT Installation

The EMS-1 provides for up to 4 thermocouple inputs when using the internal electronics and up to 12 thermocouple inputs when using the optional external RDAC. K, J as well as E-type probes can be used. K types are used for EGT probes while CHT probes can either be J or K type. E-type probes are seldom used. Probe types are selected in the various "TC SETUP" menus of the EMS-1.

Important: Incorrect selection of probe type will lead to an incorrect temperature display.

The EMS-1 will accept both grounded and isolated thermocouple probes. Your only consideration in case of the more common grounded configurations is that you need to ensure that the thermocouple mounting position (exhaust flange, etc.) is at the same electrical potential as the negative supply line of the EMS-1.

The thermocouple amplifier is a precision device providing full cold junction compensation. This results in very accurate measurements providing you install high quality probes. Here are some guidelines:

EGT Probes: Select probes that are made from 316 stainless steel and that use glass-fiber insulated conductors. Teflon insulated conductors as found in many cheap probes introduce errors as the insulation melts moving the measuring point towards the mounting bolt which transfers a lot of heat to the exhaust material. This results in under reading probes. Stay away from probes that use simple plastic heat shrink sleeving – it does not last. Choose probes that use a generous amount of stainless steel spring as strain relief. The bolt itself should be stainless steel as well or it will rust very quickly.

CHT Probes: These are made from washers to fit spark-plug bases. Temperatures are considerably lower so most thermocouple cables will work without problems. The biggest area of concern should be the connection of the thermocouple cable to the washer. This often breaks after the spark plug has been changed a few times. Choose a probe that is suitably reinforced at this point for a long and trouble free life.

EGT and CHT probes supplied by MGL Avionics are of the highest quality. We recommend that you consider using our probes if at all possible.

EGT and CHT probes use wire made from iron and other basic metals. As a result these probes are not able to withstand much flexing of the wires due to engine vibrations. Avoid making nice looking coils or similar constructions that will result in excessive vibration or flexing of the wire. Route the cables from the probe points tightly along suitable engine mounting points eliminating any chance of unnecessary wire flexing during engine operation.

Warning: Four stroke engines produce much hotter exhaust gases compared to two stroke engines. Do not use EGT probes made from lower grade stainless steel (for example 310), these probes will not withstand the high temperatures and can fail as the metal gets very soft at 800 degrees C. Many four strokes (such as the Rotax 912) will produce exhaust gases of up to 850 degrees C.

11.2.1 Extending the leads of thermocouple probes

Thermocouple leads as used with the EGT and CHT probes can be extended either with ordinary copper cable or with special K-Type extension cable. The choice of either depends on your desired accuracy. If it is possible in your installation to ensure that both ends of a copper extension cable will be at the same temperature (or very close), then it is quite possible to use the copper cable. In most open-air installations this will be the case. Should this not be possible or you require best possible accuracy at all times, you can obtain a special K-type extension cable. This cable is made from the same metals as your probes cable and uses ordinary plastic sleeving as insulation. In either case, ensure that the cable is not routed close to sources of electromagnetic interference of any kind. The voltages present in this cable are very small and are subject to changes applied by external fields. This can lead to false temperature indications. You can check your installation by using a hand-held transmitter, such as an air band radio. If you transmit a signal, no change in temperature reading should occur.

11.2.2 Notes on thermocouple connections using the supplied harness

For maximum accuracy of the thermocouple temperature measurement, please ensure that either end of the harness cable (where used for thermocouple probes) is at fairly even temperature (minimise the temperature difference between the connector side of the cable and the side where you connect the thermocouple). If required, shorten the cable to fulfil this need.

Note: Always install EGT probes starting on Channel 1 followed by the CHT probes without skipping any channels in between.

11.3 RPM Installation

The RPM 1 input is quite universal. The RPM 1 input can be used with signals from about 5Vpp to as much as 100Vpp. The input is also AC coupled for easy installation. A noise filter is included that results in the input ignoring any high frequency noise signals as long as this is below the detection threshold of about 2.5Vpp (Please see dipswitch settings below)

The input impedance of the rev counter input is approximately 10Kohm. You can use series resistors as well as load resistors for applications that have unusual signals.

The RPM 2 input is intended as a Rotor input or a RPM input from sensors that can output a TTL signal. A noise filter is included that results in the input ignoring any noise signals as long as this is below the detection threshold of about 1.5V. (Please see dipswitch settings below). The required input voltage swing must be less than 1.5V to more than 3.5V.

The 220Ohm ballast resistor can be connected across the RPM input to ground to reduce noise or secondary pulses on the RPM line (This is often used with Rotax engines). The ballast resistor must not be inserted for direct magneto pickups as the magneto pulse may have low energy in particular at idle.

After you have connected the RPM input terminals to the signal sources you will need to set the number of pulses per revolution under the "RPM SETUP" menus. The calibration itself depends on your engine and rotor type and what kind of signal you are using.

Installation of the EMS-1 is quite straight forward in most cases. The drawing in section 10.1 shows a typical EMS-1 installation. Please see the engine RPM connection guide for connecting popular engine types to the EMS-1.

11.3.1 Adjusting RPM sensitivity (RPM 1 Input only)

The EMS-1 has a sensitivity adjustment trimmer at the rear of the instrument. Adjust this trimmer using a small screwdriver such that you get stable RPM readings over the entire RPM band of your engine. If your sensitivity is too high, you may get unstable RPM readings (usually at higher RPM as electrical noise in the ignition system increases). If the sensitivity is too low the RPM reading may remain at zero. Fully clockwise = maximum sensitivity.

11.3.2 RPM 1 Input Dipswitch settings

Setting dipswitch 4 to the “ON” position (default) enables a high frequency filter in the RPM 1 signal path. Some installations (direct coupling to a Magneto device for example) will require this to be switched “OFF”. Dipswitch 4 is the closest switch to the edge of the PCB.



11.3.3 Engine RPM connection guide

Engine	Connection / Sensor	Pulses per revolution	220 Ohm Ballast resistor
Rotax 447	Connect the grey wire from the engine to the RPM input	6	Certain installations, see note below
Rotax 503	Connect the grey wire from the engine to the RPM input	6	Certain installations, see note below
Rotax 582	Connect the grey wire from the engine to the RPM input	6	Certain installations, see note below
Rotax 618	Connect the grey wire from the engine to the RPM input	6	Certain installations, see note below
Rotax 912 (S)	Connect the rev counter wires (blue/yellow and white/yellow). One of the two wires needs to be connected to ground (engine block) and the other to the RPM input.	1	Insert ballast resistor
Rotax 914	Connect the rev counter wires (blue/yellow and white/yellow). One of the two wires needs to be connected to ground (engine block) and the other to the RPM input.	1	Insert ballast resistor
Engines with magnetos	UMA Tach Sensor T1A9-1 (Slick) T1A9-2 (Bendix) Connect the red or orange/white wire to 12V, the black or blue/white and braid to ground. Connect the white (signal) to the RPM input	1 pulse per revolution on 4-cylinder, 2 pole magnetos 1.5 pulses per revolution on 6-cylinder, 2 pole magnetos	Certain installations
HKS engine	Connect the orange wire from the CDI unit to the RPM input	1	no
MTH engine	Connect the green wire from ignition sensor to the RPM input	2	no
Werner engine	Connect the yellow wire from ignition sensor to the RPM input	2	no
UL Power	Connect the ECU pin 9 to the RPM input	2	no

Note: Some Rotax engines may require that a 220 ohm ballast resistor is fitted between the rpm input and the ground terminal. This resistor should be fitted if you cannot obtain stable RPM throughout the range regardless of any setting of the rpm counter sensitivity adjustment.

11.3.4 Connecting the EMS-1 to automotive engines

Conventional contact breaker ignition system

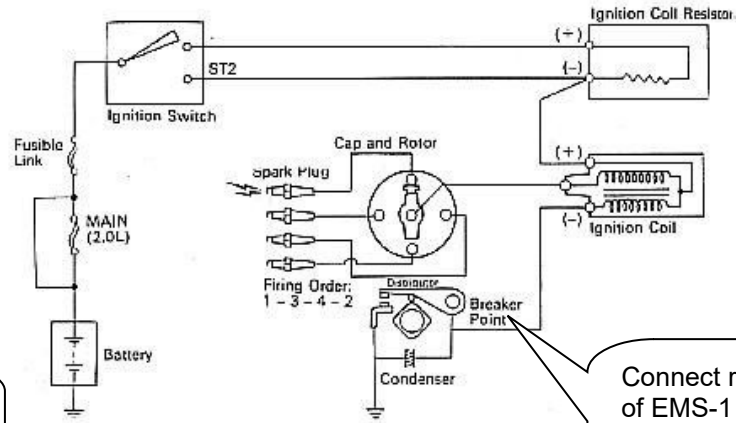

Use the tacho line if your system has such a signal

Connect rev counter input of EMS-1 to this line. Ensure you have a connection from the EMS-1 ground to the engine block.

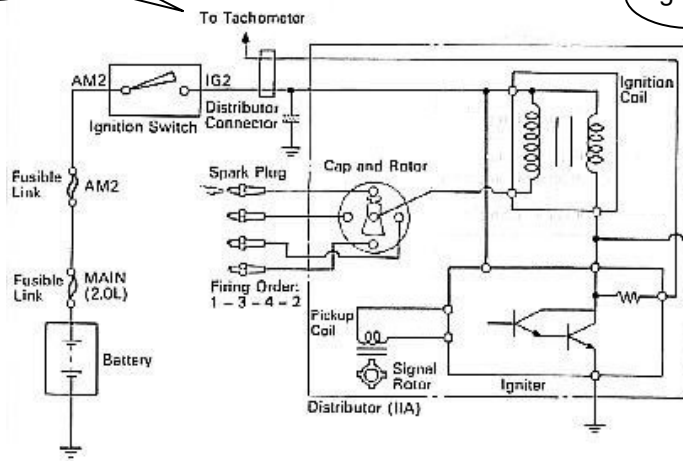

Connect rev counter input of EMS-1 to this line (Insert 10k resistor in series). Ensure you have a connection from the EMS-1 ground to the engine block.

Electronic ignition system with conventional ignition coil

11.3.5 Various other pickup / sensor installation possibilities

Hall-effect sensor

Typical hall effect sensor installation detects the passing of a magnet suitably fixed to prop flanges or shafts.

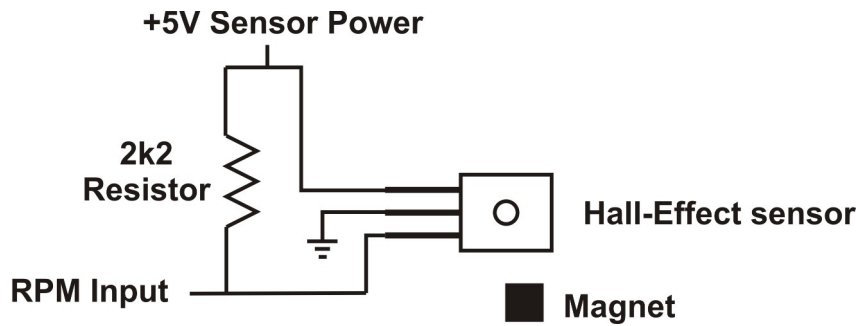

Gear tooth sensor

The gear tooth sensor is a popular pickup used on the pre-rotation gear of a gyro plane (rotor speed indication).

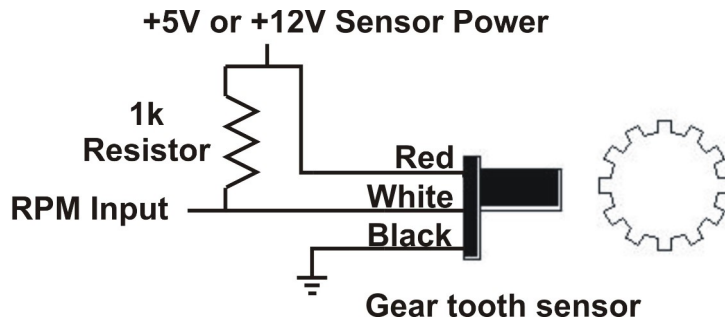

Optical Reflective Pickup

The optical reflective pickup can provide a simple means of contactless RPM sensing in difficult installations.

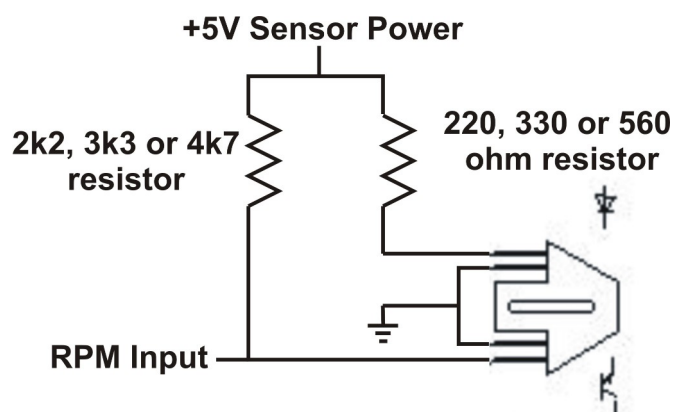

11.4 Temperature senders

VDO Resistive senders: The EMS-1 supports the VDO 120°C and 150°C thermistor automotive senders. The internal pull up resistor dip switch for the resistive temperature sender input must be in the “ON” position.

MGL NTC resistive senders: A suitable sender with the same thread used by Rotax can be obtained from MGL Avionics (manufacturer Echlin). The internal pull up resistor dip switch for the resistive temperature sender input must be in the “ON” position.

Most NTC senders require a single wire connected as shown in the installation diagram. The sender is grounded via the engine block. The ground terminal of the gauge input should be connected to the engine block. Some NTC senders have two wires. In this case it is not required that the sender housing itself is connected to the engine block. Wire the second wire to the reference ground terminal.

MGL Precision senders (On Semiconductors LM335): These are senders containing a semiconductor temperature measurement device. They can be used for water or oil temperature. These senders are available in two types: an encapsulated version with a brass housing suitable for Rotax thread; a second uncommitted version contains only the sensor itself. This can be conveniently mounted inside an existing sender housing after you remove the original insides of the sender. This is intended to give you a solution for unusual or difficult to obtain senders. The internal pull up resistor dip switch for the resistive temperature sender input must be in the “ON” position.

Connect the green wire to ground and the red wire to the analog input channel.

Westach Resistive senders: The EMS-1 supports the Westach 399 series senders. The internal pull up resistor dip switch for the resistive temperature sender input must be in the “ON” position.

User defined senders: The EMS-1 has a user sender calibration feature that can be customized for senders not listed above.

11.5 Pressure senders

VDO Resistive senders: The EMS-1 includes linearisation curves for the VDO 2, 5 and 10 Bar pressure senders. The internal pull up resistor dip switch for the resistive pressure sender input must be in the “ON” position.

4-20mA Pressure Senders: The EMS-1 supports the 4-20mA pressure sender as used in Rotax 912/914 engines. The supplied 100Ohm 1/4W resistor must be connected across the analog input channel to ground. The internal pull up resistor dip switch for the 4-20mA current sender input must be in the “OFF” position. Only channel 1 to 3 can be used for the 4-20mA pressure sender if using the internal measurement circuit and only the OILP, AUX 1 and AUX 2 can be used if using the external RDAC.

Voltage output pressure senders: The EMS-1 includes linearisation curves for the UMA N/T 1EU07, N/T 1EU35, N/T 1EU70, N/T 1EU70A, N/T 1EU100 and N/T 1EU150 pressure senders. The EMS-1 also has a 0.5-4.5V sender selection. The internal pull up resistor dip switch for the 0.5-4.5V sender input must be in the “OFF” position.

User defined senders: The EMS-1 has a user sender calibration feature that can be customized for Resistive, 4-20mA as well as Voltage output senders.

11.5.1 UMA Voltage output pressure sender



Pinout:

- White/Orange: +12Vdc
- White: Signal
- White/Blue: Ground
- Shield: Ground

11.5.2 ROTAX 912/914 4-20mA Pressure sender

DIMENSIONS for reference only mm (in)

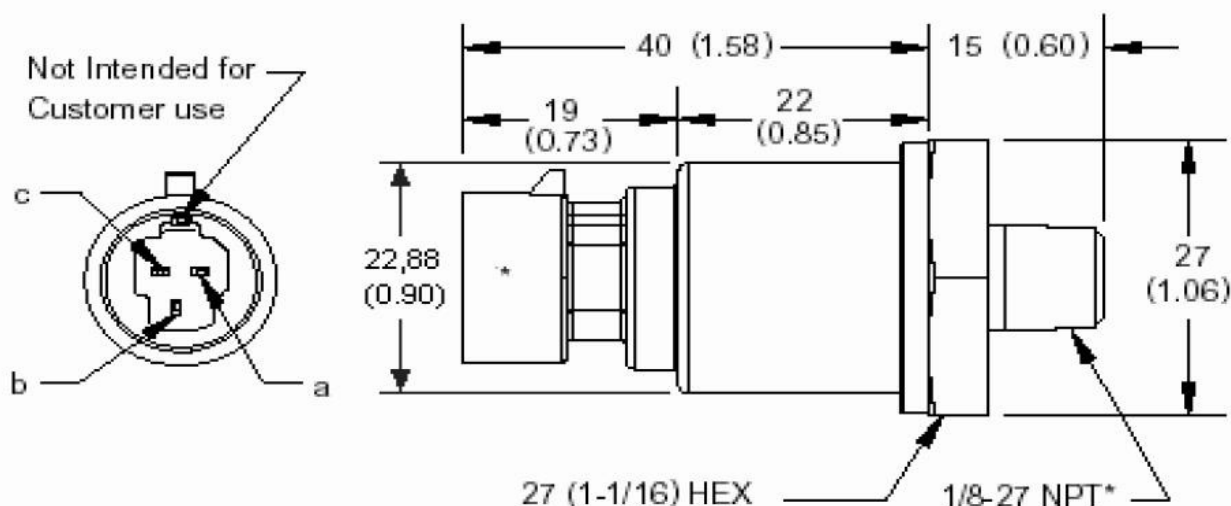

The sensor cable is approximately 3m long and has 3 leads. The black lead is not to be connected and has no function. The Red lead from the sensor has to be connected to the positive bus via a fuse or circuit breaker . The white lead (Output signal) has to be connected directly to the EMS-1 analog input channel. The supplied 100Ohm 1/4W resistor must be connected across the analog input channel to ground. The internal pull up resistor dip switch for the 4-20mA current sender input must be in the "OFF" position.

11.6 Fuel flow sender installation

The fuel flow sender allows the EMS-1 to provide instantaneous readout of hourly fuel usage.

Please note that the installation of the fuel Flow sender should be done in such a fashion that dirt or debris from the fuel tank cannot lodge inside the flow sender. These will not block you fuel flow but may lead to the impeller inside the sender jamming. It is usually sufficient to mount the flow sender AFTER the fuel filter but before the fuel pump. It is a good idea to provide a small reservoir such as a primer bulb between the flow sender and the fuel pump.

As indicated in the recommended installation drawing, it can be of advantage to install the flow sender in such a fashion that the inlet points slightly down and the outlet points slightly up. This prevents vapor from forming a bubble inside the flow sender. We strongly recommend mounting the flow sender in such a fashion that the impeller rests on only one bearing. This is achieved if you mount the sender such that the surface with the arrow faces upwards. Mounting the sender like this results in the best performance at low flow rates as only very little friction is present. The flow sender is delivered with a small jet that can be installed in the flow sender inlet. Installation of this jet is recommended for engines with fuel flow rates lower than about 30 Litres per hour. This would apply to most small two and four stroke engines. The EMS-1 is shipped with the fuel flow sender calibration set for the jet installed. In a good installation you can expect about +/- 3% maximum flow reading error with this factor. You can calibrate the flow sender yourself to a higher degree of accuracy if you so desire.

Recommended procedure to calibrate the fuel flow sender:

Note: You must disable the fuel level sender if you have one installed, and enable the calculated fuel level sender.

1. Fill your tank exactly to a known level (for example 50 Litres).
2. Set your fuel level to 50 Litres.
3. Fly your aircraft for a period that you know will use approximately 20 Litres of fuel. The exact fuel burn is not important; just burn about 20 Litres of your fuel. At the end of your flight the instrument should give you a reading of how much fuel you have left – the reading should be about 30 Litres left.
4. Now place your aircraft in exactly the same position that you used when you first filled the tank and refill the tank to 50 Litres using a measuring jug. You should find that you need 20 Litres of fuel to refill to 50 Litres.
5. If you find that the instrument under or over reads the fuel used, you should perform a simple adjustment of the fuel flow sender calibration factor.

Example:

Actual fuel used: 21.5 Litres, FF-5 fuel burn calculated 29.7 Litres left in the tank. This means the EMS-1 measured $50 - 29.7 = 20.3$ Litres. We are under reading by 1.2 Litres.

Default calibration factor in Fuel setup menu = 7000.

Let the corrected calibration factor be X.

$$X = (20.3 * 7000) / 21.5$$

$$X = 6609.3$$

The closest setting you can enter as factor is 6609. Enter it into the unit and you are done!

Repeat the above procedure to verify that your flow sender is now reading correctly.

Please note:

Before you calibrate the flow sender ensure there are no problems with your installation. We find the senders are very accurate if everything is installed and working properly. If your fuel burn indication is out by a large amount you have a problem that you should not attempt to fix by fiddling with the calibration factor! Please ensure that no fuel vapor can be trapped inside the sender housing in the form of bubbles. Due to the low fuel flow rates the bubbles will prevent the tiny impeller from turning freely, you can verify the turning of the impeller. You should notice three dark spots that are just visible in the inside of the fuel flow sender. These are small magnets that are attached to the impeller. With fuel flowing you should see the magnets turning. The best defense against vapor bubbles is to install the flow sender in such a way that the bubbles can escape. The easiest way is to point the outlet slightly upwards and the inlet (with the jet) slightly

downwards. Another possible problem is the fuel sender jet. When you install it, do not damage it. Use a drill bit of suitable diameter (5.5mm) to push the jet all the way, the opening of the jet must be just in front of the impeller.

YOU NEED TO APPLY SOME FORCE TO INSERT THE JET ALL THE WAY (about 24mm). THE JET MUST BE LOCATED RIGHT IN FRONT OF THE IMPELLOR. YOU CANNOT PUSH THE JET TOO FAR.

Using other Flow Senders

It is quite possible to use flow senders other than the MGL Avionics fuel flow sender. In this case ensure that the sender outputs a 5V TTL square wave or a similar signal. The EMS-1 interface electronics will adapt to a variety of different voltages and pulse shapes as it contains a Schmitt-trigger input stage. The calibration factor can be entered in a wide range making the unit particularly suited to other flow senders. The supply output terminal for the sender provides a positive, regulated 5 volt output. This may be used to power the flow sender provided the sender will not draw more than 40 mA of current. Should your sender require a higher voltage or more current, you must supply the sender from a different power source. Exceeding the rating on the MGL Avionics fuel flow sender supply terminal can affect the operation on the unit negatively or even damage it. Some senders require a pull-up resistor to the 12V supply line. We find most installations of these senders require a 4K7 pull-up resistor.

Recommended Calibration Factors for the MGL Avionics dual range flow sender:

With jet installed = 7000. Recommended for flow rates below 30 Litres/hour maximum

Without jet installed = 1330. Recommended for flow rates above 30 Litres/hour

Please refer to the leaflet included with the flow sender for information on pressure drop versus flow rate, wetted materials etc.

It is your responsibility to ensure that the flow sender used is compatible with the fuels you intend using. We have found the MGL Avionics fuel flow sender to be very compatible with automotive fuels used in South Africa, many of which contain methanol. 100LL AVGAS also appears not to harm the sender in any way. We have exposed a sender continuously to our automotive fuels for the duration of two years without any noticeable ill effect on the sender. However, despite this MGL Avionics or its appointed agents cannot assume responsibility for any incident or damage, even loss of life by whatsoever cause connected with the fuel flow sender or the EMS-1 instrument. Usage of this or other senders is your own sole responsibility.

If you do not agree with the above statement you must not use the fuel flow sender.

Note to Pilots: (Even though this is the installation manual)

You must always have a visual indication of the fuel level available, either by means of a sight glass, direct tank observation or a known, reliable secondary fuel level gauge. As pilot in command of an aircraft it is your responsibility to ensure that you have sufficient fuel to reach your intended destination. Always ensure that you have a generous amount of reserve fuel and never use your reserve fuel except in an emergency if it is unavoidable.

11.7 Fuel level senders

The EMS-1 permits the connection of standard automotive fuel level senders. These senders can be obtained at automotive spares outlets at reasonable cost. When you choose a float level sender, ensure that you select a model that is sturdy and promises reliable and long lifetime. In particular, select a model that does not have any metal parts that can rust. The EMS-1 can interface to a large variety of these fuel level senders. It does not matter if the sender resistance increases or decreases with the fuel level as long as it changes. The calibration procedure outlined in the “Fuel Level Setup” section describes in great detail the procedure to follow.

In essence, the calibration procedure will measure the resistance of the fuel level sender at various fuel levels and then work out the readings in between those known settings. Typical fuel level senders that can be used with the EMS-1 have resistance ranges in the region of 100 ohms to 500 ohms. Connect the flange of the sender to the negative supply (ground). You can connect capacitive senders as well. These generally come in two types: The first emulates a normal resistive probe and is simple to connect and use as a result. The second type has a voltage level output. These can be used if the voltage can be set to a range of about 0-5V. Higher voltage levels will result in the instrument assuming a problem.

We recommend using VDO float based fuel level senders. Capacitive types can be used provided they have a voltage output not exceeding 5V. The analog inputs have an internal 1K5 resistor pull-up to +5V. Please note that capacitive senders may exhibit large errors as they are very sensitive to the composition of the fuel used. We do not recommend using capacitive senders with automotive fuels for this reason.

Note: It might be advantageous to disable the internal pull up resistor via the analog dipswitch and provide a calculated external resistor connected between the analog channel input and the +5V sensor power. This can lead to an increased ADC resolution providing a better fuel tank indication. The internal pull up resistor in the EMS-1 is 1k5 ohms.

Safety Hazard! Please take note:

Be careful when installing fuel level senders into fuel tanks. Ensure that the fuel tank is completely empty when you proceed with the installation. Ensure that the fuel tank is well ventilated and does not contain any fuel vapors – these are highly explosive when mixed with air. Ensure that at all times the ground connection (the connection of the fuel level sender mounting flange) is securely connected to the aircraft frame (in case of a metal frame) and to the negative terminal of the battery. In addition the negative terminal of the battery must at all times be connected to the supply ground terminal of the EMS-1. Please note – this wiring is critical and must never break in flight. It would be possible to create electrical sparks in the fuel tank if your wiring is faulty or incorrect. The consequences of this can be imagined. This has nothing to do with the EMS-1 itself but is a general hazard for any automotive fuel level sender installation. If you have no experience with electrical wiring, **PLEASE** delegate the task to a qualified automobile electrician or electronics technician. If you need to remove the EMS-1, please first disconnect and secure the fuel level sender wire before disconnecting anything else.

11.8 Analog Channels Dipswitch settings

Use a small screwdriver to change the switch direction.

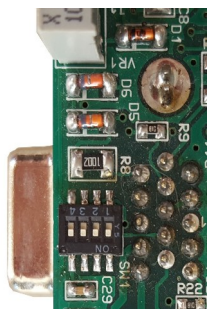

Dipswitch	Function
1	Analog Input Channel 1 Pull up resistor (On=Enable, OFF=Disable)
2	Analog Input Channel 2 Pull up resistor (On=Enable, OFF=Disable)
3	Analog Input Channel 3 Pull up resistor (On=Enable, OFF=Disable)
4	Enables a high frequency filter in the RPM 1 signal path (On=Enable, OFF=Disable)

11.9 Manifold Pressure Installation (RDAC Only)

Standard polyester or silicon hosing with an inside diameter of 3-4mm is suitable as pressure hosing. For high pressure applications the hose should be clamped onto the connector to avoid it slipping off due to expansion of the hose. For applications where a pressure leak may prove troublesome, such as a typical engine manifold application, a restrictor valve should be inserted into the hose so that only very little gas leakage will be present in a case of failure or if the instrument is removed with the engine running.

In the case of the 912 and 914 Rotax engines there is a pipe connecting the two manifolds where this connection can be made.

11.10 OAT Probe



Connect the OAT probe red wire to the EMS-2 analog input and the black or green wire to ground.

11.11 Closed Loop Current Sensor

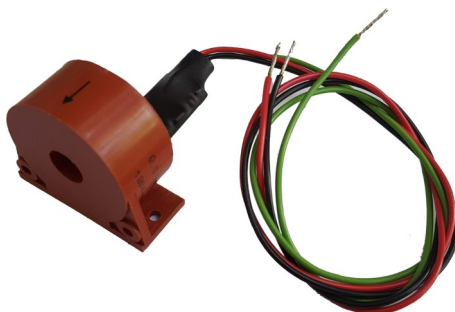

The MGL Avionics magnetic closed loop current sensor provides a 0.5V to 4.5Vdc output voltage which is proportional to a 50A bi-directional input current.

Advantages of closed loop current sensors over conventional current measurements techniques is that they provide the highest accuracy, are ideal for noisy electrical environments and they provide complete electrical isolation from the current carrying conductor.

Please see the Closed Loop Current Sensor manual for connection information

11.12 Datalogger (LOG-1)

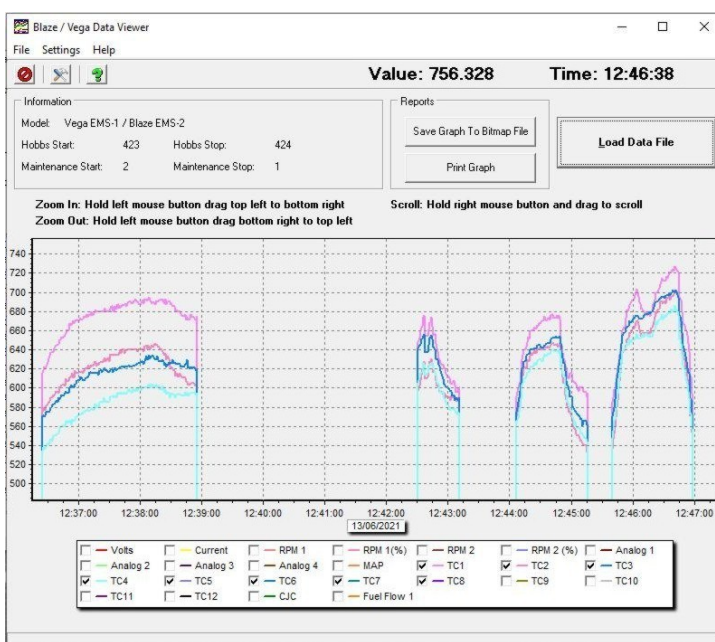

The LOG-1 is a datalogger for the Blaze and Vega range of instruments. Serial Information is received via the RS232 port and recorded to the SD card.

The data on the SD card is stored in a Comma Separated Values (.CSV) file that can easily be opened in a spreadsheet or text viewer type program or alternatively the data can be viewed using the free Blaze / Vega Data Viewer PC program.

The Blaze / Vega Data Viewer PC program can be downloaded from the MGL Avionics website.

11.13 Senders that are grounded in the engine block

Single wire senders require that their mounting arrangement (thread) has a very good electrical contact with the engine block. Avoid the use of any sealant or tapes as these may cause a bad electrical connection. Further to this it is very important that the engine block has a good electrical connection to the negative supply terminal of the EMS-1. Any voltage drop caused by other equipment on the ground wire will cause incorrect readings. The best way to ensure a good connection is to wire a single connection between the EMS-1 ground terminal (any of these terminals) and the engine block. Do not wire this anywhere else and do not allow any other equipment to use this wire as a current return path.

11.14 External RDAC (Remote Data Acquisition) Connection (Optional)

The EMS-1 can use an external RDAC unit as the source for the analog signals. Using an external RDAC may be beneficial as it will reduce the wiring from the engine compartment to the cockpit. Only the CAN High and CAN Low connections need to be made between the RDAC unit and the EMS-1 in order for this to work. Select "RDAC" for the data source in the various setup menus if using the external RDAC option. The RDAC unit is optional and is purchased separately.

EMS-1 Analog Channel 1 = RDAC OILT

EMS-1 Analog Channel 2 = RDAC OILP

EMS-1 Analog Channel 3 = RDAC AUX1

EMS-1 Analog Channel 4 = RDAC AUX2

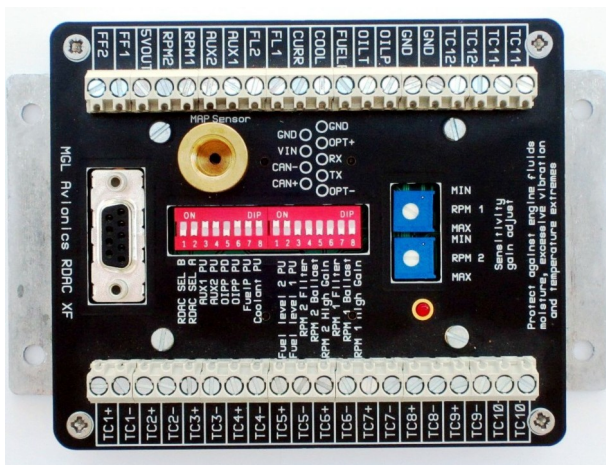

11.15 Cable connections

Main connector (D15HD connector: Unit Female, Cable Male)

D15HD Pin	Wire Color	Function
1	Red	8-30Vdc power via power switch / circuit breaker and fuse.
2	Black	Ground. Connect the ground to the engine block, and the engine block to the battery negative. Do not connect the EMS-1 ground directly to the battery negative. This must be routed via the engine block.
3	White/Blue Stripe	RS232 Transmit data (Firmware upgrading)
4	White/Black Stripe	RS232 Receive data (Firmware upgrading)
5	Green	Analog Input 2
6	Yellow	RPM 2 Input (Rotor RPM / TTL signal sensor sources) / Fuel flow Input
7	Orange	Analog Input 1
9	Red/White Stripe	Analog Input 4
10	Grey	Analog Input 3
11	Blue	RPM 1 Input (Engine RPM)
12	Purple	CAN Low (Used for optional external RDAC)
13	Pink	CAN High (Used for optional external RDAC)
14	Brown	+5Vdc Power out Sensor power
15	White	Alarm Output (Open collector)

Thermocouple (EGT/CHT) connector (D9 connector: Unit Male, Cable Female)

In case of MGL Avionics K-Type probes + = Yellow probe lead, - = Red probe lead

D9 Female Pin	Color	Function
5	Blue	TC Channel 1 +
4	Orange	TC Channel 2 +
3	Green	TC Channel 3 +
2	Purple	TC Channel 4 +
9	Red	TC Channel 1 -
8	Brown	TC Channel 2 -
7	Yellow	TC Channel 3 -
6	White	TC Channel 4 -

12 Dimensions

Stratomaster Vega 2.25" (57mm) Dimensions

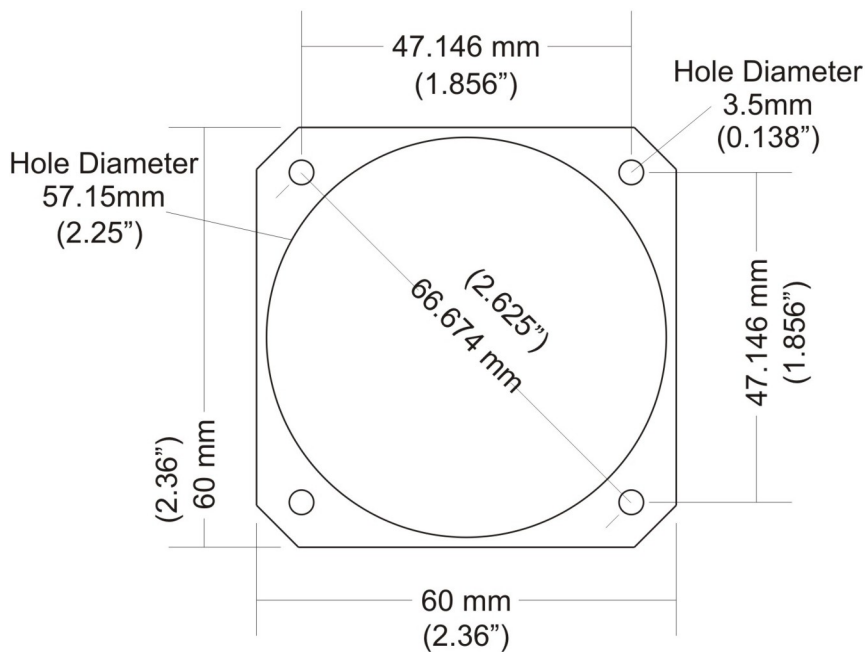

FRONT VIEW

3mm (0.118") mounting screws recommended

NOTE: 57.15mm (2.25") is a standard cutout, but due to manufacturing tolerances, 58mm (2.28") is found to be more desirable.

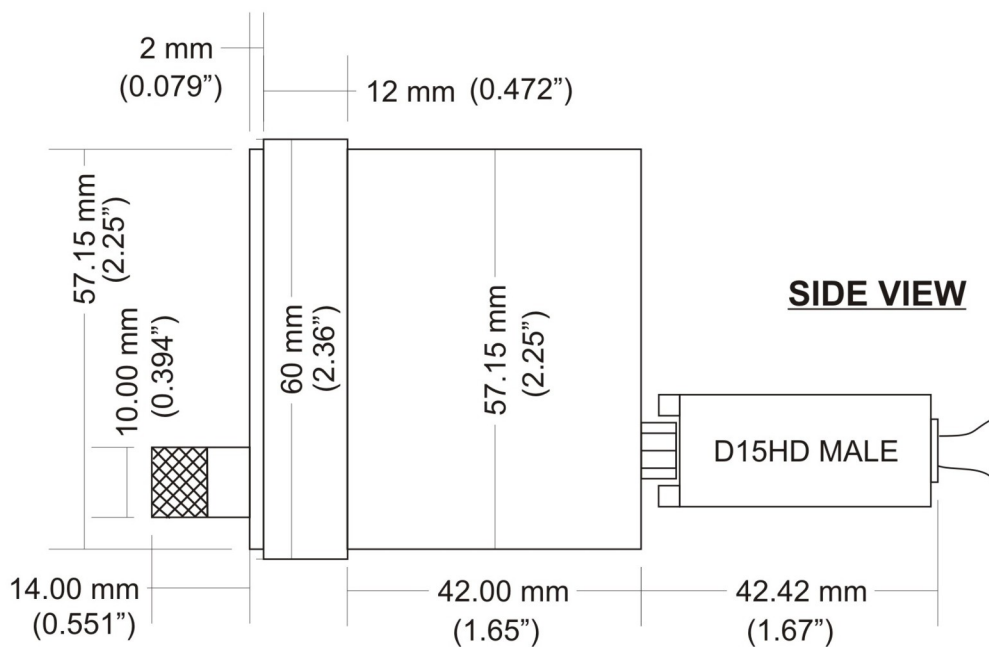

SIDE VIEW

13 Cleaning

The unit should not be cleaned with any abrasive substances. The screen is very sensitive to certain cleaning materials and should only be cleaned using a clean, damp cloth.

Warning: The EMS-1 is not waterproof, serious damage could occur if the unit is exposed to water and/or spray jets.

14 Warranty

This product carries a warranty for a period of one year from date of purchase against faulty workmanship or defective materials, provided there is no evidence that the unit has been mishandled or misused. Warranty is limited to the replacement of faulty components and includes the cost of labor. Shipping costs are for the account of the purchaser.

Note: Product warranty excludes damages caused by unprotected, unsuitable or incorrectly wired electrical supplies and or sensors, and damage caused by inductive loads.

15 Disclaimer

Operation of this instrument is the sole responsibility of the purchaser of the unit. The user must make themselves familiar with the operation of this instrument and the effect of any possible failure or malfunction.

This instrument is not certified by the FAA. Fitting of this instrument to certified aircraft is subject to the rules and conditions pertaining to such in your country. Please check with your local aviation authorities if in doubt. This instrument is intended for ultralight, microlight, home built and experimental aircraft. Operation of this instrument is the sole responsibility of the pilot in command (PIC) of the aircraft. This person must be proficient and carry a valid and relevant pilot's license. This person has to make themselves familiar with the operation of this instrument and the effect of any possible failure or malfunction. Under no circumstances does the manufacturer condone usage of this instrument for IFR flights.

IMPORTANT NOTICE:

You must make your own determination if the products sold by MGL Avionics are safe and effective for your intended applications. MGL Avionics makes no representations or warranties as to either the suitability of any of the products we sell as to your particular application or the compatibility of any of the products we sell with other products you may buy from us or anywhere else, and we disclaim any warranties or representations that may otherwise arise by law. Also, we offer no specific advice on how to install any of the products we sell other than passing along anything that may have been provided to us by the manufacturer or other issues. If you are in need of further information or guidance, please turn to the manufacturer, FAA Advisory Circulars and guidance materials, the Experimental Aircraft Association, or other reputable sources.

Continuing development sometimes necessitates specification changes without notice.

Other instruments in the *Stratomaster Vega* series

AHRS-1	Artificial Horizon and Magnetic Compass Indicator
AHRS-3	Self contained Artificial Horizon and Magnetic Compass Indicator
ALT-5	Altimeter and Vertical Speed Indicator (VSI)
ASI-4	Airspeed Indicator (ASI)
ASV-1	Altimeter, Airspeed (ASI) and Vertical Speed Indicator (VSI)
EMS-1	Engine Monitoring System
FF-4	Fuel Computer
INFO-1	Information Display (G-Force meter, UTC and Local Time, Slip Indicator, Outside Air Temperature (OAT), Battery Voltage, Current and charge display, Flight Timer & Flight Log, Stopwatch, Countdown Timer and Alarm)
MAG-1	Magnetic Compass Indicator
MAP-3	Manifold Pressure and RPM Indicator
RPM-1	Universal Engine / Rotor RPM Indicator
TC-4	4 Channel Thermocouple (EGT/CHT) Indicator
TP-3	4 Channel Universal Analog Input (Pressure/Temperature/Current/Volts) Indicator